



CP9690 Elite AutoScanner®



en User guide

Serial No: _____

SW ID: _____

HW Ver: _____

Boot Ver: _____

Prod ID: _____

Board ID: _____

Burn Date: _____

Record the above information about your tool. The information is available at Main Menu --> System Setup --> Tool Information. Provide this information when contacting technical support.

If you have questions or concerns contact Technical Support:

Phone: 800-228-7667

E-mail: tech@actron.com

The information, specifications and illustrations in this guide are based on the latest information available. Bosch reserves the right to make changes at any time without notice.

Table of Contents

1	Safety Precautions	5	4.7	Code Lookup	21
	1.1 Read All Instructions	5	4.8	Locating Data Link Connector	22
	1.2 Safety Messages	5	4.9	Connect the Tool	22
2	Important Safety Warnings and Instructions . .	5	4.10	Vehicle Selection	22
3	Getting Started	8	4.11	CodeConnect® Feature	24
	3.1 Introduction	8	4.12	Code Criteria	25
	3.2 Download Scanning Suite	8	4.13	Acronyms	25
	3.3 Introduction to On-Board Diagnostics . .	8	4.14	Component Locator	26
	OBD I	8	5	OBD II Diagnostics	26
	OBD II	8	5.1	I/M Monitors (Emissions)	27
	3.4 SAE Publications	8	5.2	Read Codes	28
	3.5 Data Link Connector (DLC)	9	5.3	Erase Codes	30
	OBD II (J1962)	9	5.4	MIL Status	31
	OBD II Data Link Connector (DLC) Pins . .	9	5.5	State OBD Check	32
	Ford (OBD I)	9	5.6	View Data	32
	GM (OBD I)	10		View Entire List	33
	Chrysler (OBD I)	10		Custom List Select	33
	Toyota (OBD I)	11	5.7	Record Data	34
	3.6 OBD II Diagnostic Trouble Codes (DTCs)	11	5.8	View Freeze Data	35
	Powertrain Codes	12	5.9	Drive Cycle Monitor	36
	Chassis Codes	12	5.10	O2 Monitor Tests	37
	Body Codes	12	5.11	Diagnostic Monitor Tests	38
	Network Communication Codes	12	5.12	On-Board Systems	39
4	Using the Scan Tool	12	5.13	Vehicle Information	39
	4.1 The Scan Tool	12	5.14	Oil Light Reset	41
	4.2 Specifications	13	5.15	Battery Reset	42
	Dimensions	13		Battery Information	42
	Accessories	13	5.16	Charging System Monitor	43
	Optional Accessories	13	5.17	Modules Present	44
	4.3 Display	13	6	GM OBD I Diagnostics	45
	Keypad	13	6.1	Diagnostic Menu	45
	4.4 Power	13	6.2	View Data	45
	Internal Battery Power	13	6.3	Record Data	46
	Vehicle Power	14	6.4	Read Codes	46
	USB Power	14	6.5	Erase Codes	47
	4.5 System Setup	14	6.6	Manual Erase Methods	47
	Changing Measurement Units	14		Alternate Method 1:	47
	Changing Auto-Power Off	14		Alternate Method 2:	48
	Quick Test	15	6.7	Field Service	48
	Print Header	15		KOEO Procedure	48
	Language Setup	16		KOER Procedure	49
	Long PID Names	16	7	Ford OBD I Diagnostics	49
	Pre-Trigger Setup	16	7.1	Diagnostic Menu	49
	Tool Information	17		Read KOEO Fast Codes / Read KOEO Slow	50
	Display Test	17		Codes	50
	Keypad Test	18		Read KOER Fast Codes / Read KOER Slow	51
	Memory Test	18		Codes	51
	Program Mode	19	7.2	Erase Codes	52
	4.6 Vehicle-Specific Features	19		EEC-IV Erase Codes	52
	Review Data	19		MECS Erase Codes	52
	Recording	20	7.3	IVSC-Speed Ctrl (EEC-IV Vehicles)	53
	Print Data	21		Reading IVSC KOEO Codes	53
				Reading IVSC KOER Codes	53
			7.4	Wiggle Test (EEC-IV Vehicles)	54

7.5	Output Switch Test (EEC-IV Vehicles) . . .	55
7.6	Cylinder Balance Test (EEC-IV Vehicles)	55
7.7	KOER Computed Timing (1984-1991 EEC-IV Vehicles)	56
7.8	STAR Test Mode (EEC-IV, MECS and MCU Vehicles)	57
<hr/>		
8	Chrysler OBD I Diagnostics	58
8.1	Diagnostic Menu	58
8.2	View Data	58
8.3	Record Data	59
8.4	Read Codes	59
8.5	Erase Codes	60
<hr/>		
9	Toyota OBD I Diagnostics	60
9.1	Diagnostic Menu	60
9.2	Read Codes	60
9.3	Erase Codes	61
<hr/>		
10	Troubleshooting	61
10.1	Error Messages	61
10.2	Scan Tool Does Not Power Up	62
10.3	Vehicle Communication Fault	62
10.4	Operating Error or Erroneous Data	62
10.5	Battery Replacement	62
10.6	Tool Self-Tests	62
10.7	Technical Support	63
<hr/>		
11	Appendix A—Global OBD II PID Definitions . . .	63
<hr/>		
12	Appendix B—Glossary	65
<hr/>		
13	Appendix C—OBD I Data Link Connectors . . .	70
	94-95 GM Cars, Light Trucks & Vans	70
	Ford, Lincoln & Mercury Cars, Light Trucks & Vans.	71
	Chrysler Cars, Light Trucks & Vans	73
<hr/>		
14	Limited Warranty	75
<hr/>		

1 Safety Precautions

For your safety, read this manual thoroughly before operating your scan tool. Always refer to and follow safety messages and test procedures provided by the manufacturer of the vehicle or equipment being tested. The safety messages presented below and throughout this user's manual are reminders to the operator to exercise extreme care when using this test instrument.

1.1 Read All Instructions

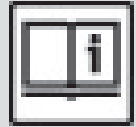

Read and understand the user guide before operating the tool.

Read, understand, and follow all safety messages and instructions in this manual and on the test equipment. Safety messages in this section of the manual contain a signal word with a three-part message and, in some instances, an icon.

1.2 Safety Messages

Safety messages are provided to help prevent personal injury and equipment damage. All safety messages are introduced by a signal word. The signal word indicates the level of the hazard in a situation. The types of safety messages are.



DANGER

Indicates a possible hazardous situation which, if not avoided, will result in death or serious injury to operator or bystanders.



WARNING

Indicates a possible hazardous situation which, if not avoided, could result in death or serious injury to operator or bystanders.



CAUTION

Indicates a possible hazardous situation which, if not avoided, may result in moderate or minor injury to operator or bystanders.



IMPORTANT

Indicates a condition which, if not avoided, may result in damage to test equipment or vehicle.

2 Important Safety Warnings and Instructions

WARNING



Risk of electric shock.

- Do not exceed voltage limits between inputs indicated in the Specifications.
- Use extreme caution when working with circuits that have voltage greater than 60 volts DC or 24 volts AC.

Electric shock can cause injury.

WARNING

Risk of poisoning.

- Safety goggles and protective clothing must be worn by the operator and any bystanders.
 - Even if everyday glasses have impact resistant lenses, they are NOT safety glasses, and may not provide adequate protection.
 - Do not use this scan tool in environments where explosive vapors may collect. These areas include:
 - below-ground pits.
 - confined areas.
 - areas that are less than 18 inches above floor.
 - Use this scan tool in locations with mechanical ventilation providing at least 4 air changes per hour.
 - Flammable fuel and vapors can ignite.
 - Do not smoke, strike a match, or cause a spark in the vicinity of the battery. Battery gases can ignite.
 - Avoid making an accidental connection between the battery terminals. Do not place uninsulated metal tools on the battery.
 - When removing battery cables, remove the ground cable first.
 - Avoid sparks when connecting or disconnecting power leads to the battery.
 - Make sure ignition is off, headlights and other accessories are off and vehicle doors are closed before disconnecting the battery cables.
 - This also helps prevent damage to on-board computer systems.
 - Always disconnect the battery ground connections before servicing electrical system components.
- Explosion can cause injury.





WARNING

- Risk of poisoning.
- Use this scan tool in locations with mechanical ventilation providing at least 4 air changes per hour. Engine exhaust contains odorless gas which can be lethal.
 - Route the exhaust outside while testing with the engine running.
- Poisoning can result in death or serious injury.



WARNING

- Battery acid is a highly corrosive sulfuric acid.
- Safety goggles and protective gloves must be worn by the operator and any bystanders.
 - Even if your everyday glasses have impact resistant lenses, they are NOT safety glasses, and may not provide adequate protection.
 - Make sure someone can hear you or is close enough to provide aid when working near a battery.
 - Have plenty of fresh water and soap nearby.
 - If battery acid contacts skin, clothing, or eyes, flush exposed area with soap and water for 10 minutes. Seek medical help.
 - Do not touch eyes while working near battery.
- Battery acid can burn eyes and skin.



WARNING

- Risk of fire.
- Safety goggles and protective clothing must be worn by the operator and any bystanders.
 - Even if your everyday glasses have impact resistant lenses, they are NOT safety glasses, and may not provide adequate protection.
 - Do not position your head directly in front of or over the throttle body.
 - Do not pour gasoline down the throttle body when cranking or running the engine, when working with fuel delivery systems or any open fuel line.
 - Engine backfire can occur when the air cleaner is out of position.
 - Do not use fuel injector cleaning solvents when performing diagnostic testing.
 - Keep cigarettes, sparks, open flame and other sources of ignition away from vehicle.
 - Keep a dry chemical (Class B) fire extinguisher rated for gasoline, chemical and electrical fires in work area.
- Fire can cause death or serious injury.



WARNING

- Risk of flying particles.
- Safety goggles and protective gloves must be worn by the operator and any bystanders while using electrical equipment.
 - Electrical equipment or rotating engine parts can cause flying particles.
 - Even if your everyday glasses have impact resistant lenses, they are NOT safety glasses, and may not provide adequate protection.
- Flying particles can cause eye injury.



WARNING

- Risk of burns.
- Batteries can produce a short-circuit current high enough to weld jewelry to metal.
 - Remove jewelry such as rings, bracelets and watches before working near batteries.
- Short circuits can cause injury.



WARNING

- Risk of burns.
- Do not remove radiator cap unless engine is cold.
 - Pressurized engine coolant may be hot.
 - Do not touch hot exhaust systems, manifolds, engines, radiators, sample probe.
 - Wear insulated gloves when handling hot engine components.
 - Tester leads can become hot after extended testing in close proximity to manifolds.
- Hot components can cause injury.



WARNING

- Risk of expelling fuel, oil vapors, hot steam, hot toxic exhaust gases, acid, refrigerant and other debris.
- Safety goggles and protective clothing must be worn by the operator and any bystanders.
 - Even if your everyday glasses have impact resistant lenses, they are NOT safety glasses, and may not provide adequate protection.
 - Engine systems can malfunction, expelling fuel, oil vapors, hot steam, hot toxic exhaust gases, acid, refrigerant and other debris.
- Fuel, oil vapors, hot steam, hot toxic exhaust gases, acid, refrigerant and other debris can cause serious injury.

WARNING

Engine compartment contains electrical connections and hot or moving parts.



- Keep yourself, test leads, clothing and other objects clear of electrical connections and hot or moving engine parts.
- Do not wear watches, rings, or loose fitting clothing when working in an engine compartment.
- Do not place tools or test equipment on fenders or other places in engine compartment.
- Barriers are recommended to help identify danger zones in test area.
- Prevent personnel from walking through test area.

Contacting electrical connections and hot or moving parts can cause injury.

WARNING

Risk of injury.



- The scan tool should be operated by qualified personnel only.
- Use the scan tool only as described in the user's manual.
- Use only manufacturer's recommended attachments.
- Do not operate the scan tool with damaged cables.
- Do not operate the scan tool if it has been dropped or damaged, until examined by a qualified service representative.

Operation of the scan tool by anyone other than qualified personnel may result in injury.

WARNING

Risk of unexpected vehicle movement.



PRNDL2

- Block drive wheels before performing a test with engine running.
- Unless instructed otherwise:
 - set parking brake
 - put gear selector in neutral for manual transmissions
 - put gear selector in park for automatic transmissions
 - disconnect release mechanism on the automatic parking brake release for testing and reconnect when testing is completed.
- Do not leave a running engine unattended. A moving vehicle can cause injury.

CAUTION

Risk of equipment or circuit damage.



- Unless specifically directed by manufacturer, make sure ignition is off before connecting or disconnecting connectors or any vehicle electrical terminals.
- Do not create a short between battery terminals with a jumper wire or tools. Improper equipment use can cause equipment or circuit damage.

CAUTION

Misdiagnosis may lead to incorrect or improper repair and/or adjustment.



- Do not rely on erratic, questionable, or obviously erroneous test information or results.
 - If test information or results are erratic, questionable, or obviously erroneous, make sure all connections and data entry information are correct and test procedures were performed correctly.
 - If test information or results are still suspicious, do not use them for diagnosis.

Improper repair and/or adjustment may cause vehicle or equipment damage or unsafe operation.

DANGER

Some vehicles are equipped with air bags.



- Follow service manual warnings when working around air bag components or wiring.
 - If service manual instructions are not followed, an air bag may deploy unexpectedly, resulting in injury.
 - Note an air bag can still deploy several minutes after ignition key is off (or even if vehicle battery is disconnected) because of a special energy reserve module.

An air bag opening can cause injury.

3 Getting Started

3.1 Introduction

The scan tool was developed by experts in the automotive service industry to help diagnose vehicles and assist in troubleshooting procedures.

The scan tool monitors vehicle events and retrieves codes from the vehicle's control modules to help pinpoint problem areas.

All information, illustrations and specifications contained in this manual are based on the latest information available from industry sources at the time of publication.

No warranty (expressed or implied) can be made for its accuracy or completeness, nor is any responsibility assumed by the manufacturer or anyone connected with it for loss or damages suffered through reliance on any information contained in this manual or misuse of accompanying product. The manufacturer reserves the right to make changes at any time to this manual or accompanying product without obligation to notify any person or organization of such changes.

3.2 Download Scanning Suite

- Go to www.actron.com/updates-downloads to download the Scanning Suite PC application. Scanning Suite is NOT required to operate the scan tool.
- Install the downloaded Scanning Suite application before connecting the scan tool to the PC. To be able to use Scanning Suite the PC must meet the following minimum requirements:
 - Microsoft Windows 7, 8, and 10.
 - Adobe Acrobat Reader
 - Screen Resolution of 800 x 600
 - If screen resolution is 800 x 600, in Display Properties, Settings Tab, set Font Size to Small Fonts.
- Some items included with the Scanning Suite are:
 - Tool update software
 - Print capture
 - Other product information
- Use Scanning Suite to determine if any updates are available for your tool by clicking Check for Update button.
- Check for updates to Use Scanning Suite by clicking on the Check For Scanning Suite Update button. This should be done before checking for Tool Updates.

You can also configure the Scanning Suite Frequency (SS Frequency) to automatically check every xx minutes. The default frequency is 7 days.

Refer to instructions provided on www.actron.com/updates-downloads for how to install Scanning Suite and Tool updates.

3.3 Introduction to On-Board Diagnostics

OBD I

The original on-board diagnostics (OBD I) lacked consistency in communication and interface while allowing different interpretations among vehicle manufacturers. Ford and Chrysler used different types of engine control computers and data link connectors (DLC), and GM varied the diagnostic trouble codes (DTCs) and communication protocols from year-to-year. OBD I usually applies to 1995 and older vehicles.

OBD II

On-Board Diagnostics version II (OBD II) is a system that the Society of Automotive Engineers (SAE) developed to standardize automotive electronic diagnosis.

Beginning in 1996, most new vehicles sold in the United States were fully OBD II compliant.

Technicians can now use the same tool to test any OBD II compliant vehicle without special adapters. SAE established guidelines that provide:

- A universal OBD II data link connector, called the DLC, with dedicated pin assignments.
- A standard location for the DLC, visible under the dash on driver's side.
- A standard list of diagnostic trouble codes (DTCs) used by all manufacturers.
- A standard list of parameter identification (PID) data used by all manufacturers.
- Ability for vehicle systems to record operating conditions when a fault occurs.
- Expanded diagnostic capabilities that records a code whenever a condition occurs that affects vehicle emissions.
- Ability to clear stored codes from the vehicle's memory with a scan tool.

3.4 SAE Publications

SAE has published hundreds of pages of text defining a standard communication protocol that establishes hardware, software, and circuit parameters of OBD II systems. Unfortunately, vehicle manufacturers have different interpretations of this standard communications protocol. As a result, the generic OBD II communications scheme varies, depending on the vehicle. SAE publishes recommendations, not laws, but the Environmental Protection Agency (EPA) and California Air Resources Board (CARB) made many of SAE's recommendations legal requirements that vehicle manufacturers were required to phase in over a three-year period. Beginning in 1994, vehicles with a new engine management computer (about 10% of each manufacturers fleet) were supposed to comply with OBD II standards. For 1995, OBD II systems were to appear on about 40% of the new vehicles sold in the United States. Some of the 1994-1995 OBD II systems were not fully compliant, so the Government granted waivers to give manufacturers time

to fine-tune their systems. Beginning in 1996, most of the new vehicles sold in the United States were fully OBD II compliant.

3.5 Data Link Connector (DLC)

The data link connector (DLC) allows the scan tool to communicate with the vehicle's computer(s). Before OBD II, manufacturers used different DLCs to communicate with the vehicle. Use the proper DLC adapter cable to connect the scan tool to the vehicle. Also, the vehicle's DLC may be found in several different places and have many different configurations. The scan tool supports OBD I DLCs used by Ford, GM, Chrysler, and Toyota.

OBD II (J1962)

Beginning in 1996, vehicles sold in the United States use the J1962 (OBD II) DLC, a term taken from a physical and electrical specification number assigned by the SAE (J1962). The DLC should be located under the dashboard on the driver's side of the vehicle. If the DLC is not located under the dashboard as stated, a decal describing its location should be attached to the dashboard in the area the DLC should have been located. For more information on OBD II connectors, go to <http://www.obdclearinghouse.com/oemdb>.

Because the OBD II J1962 connector has power and ground, you only need a single cable connection to the tool for both power and vehicle communications. Attach the OBD II adapter cable (7-0138) to the extender cable (7-0137) (both supplied with the scan tool), to connect the tool. Certain pins in the connector are reserved.

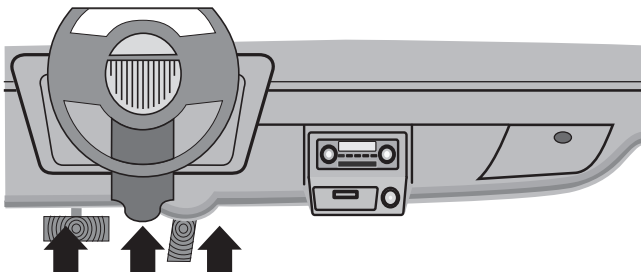

OBD II Data Link Connector (DLC) Pins

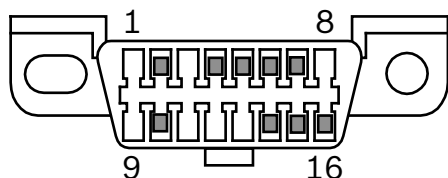

1. Manufacturer reserved
2. J1850 bus+
3. Manufacturer reserved
4. Chassis ground
5. Signal ground
6. CAN high, J-2284

7. K line, ISO 9141-2 & ISO/DIS 14230-4
8. Manufacturer reserved
9. Manufacturer reserved
10. J1850 Bus-
11. Manufacturer reserved
12. Manufacturer reserved
13. Manufacturer reserved
14. CAN low, J-2284
15. L line, ISO 9141-2 & ISO/DIS 14230-4
16. Battery power

Ford (OBD I)

Ford used three types of DLCs with their OBD I systems. After vehicle selection, the scan tool will indicate which cable is required.

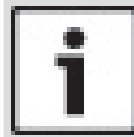

IMPORTANT

Use the included cigarette lighter cable (7-0135) to provide power to the scan tool for all systems.

EEC-IV

The **EEC-IV** DLC is a large 6-sided connector with a pigtail connector. The EEC-IV cable adapter (7-0140) is included with the scan tool.

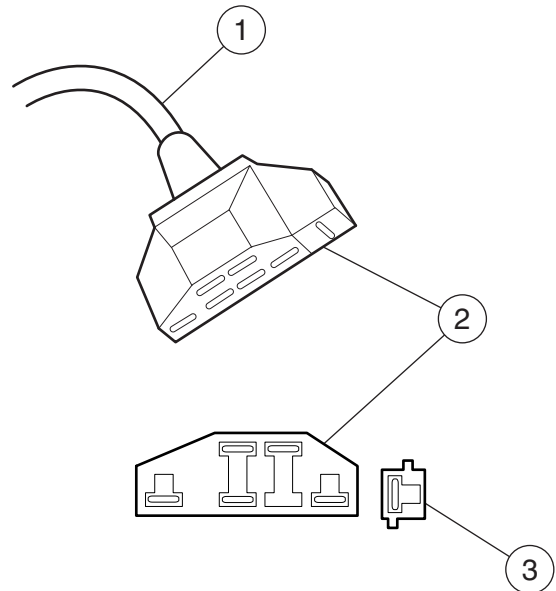

Cable Adapter EEC-IV P/N 7-0140

1. To scan tool
2. Vehicle DLC EEC-IV
3. STI Pigtail (EEC-IV only)

MECS

MECS vehicles (1988 –1995) use either a 6-pin (with pigtail) or a 17-pin DLC. Use the MECS 6-pin adapter cable kit (7-0143) for both configurations. The MECS adapter cable kit includes jumper wires to connect to the MECS 17-pin DLC. The MECS adapter cable kit is not

included with this tool. It is available through your dealer. Use the following diagrams to connect the adapter cable.

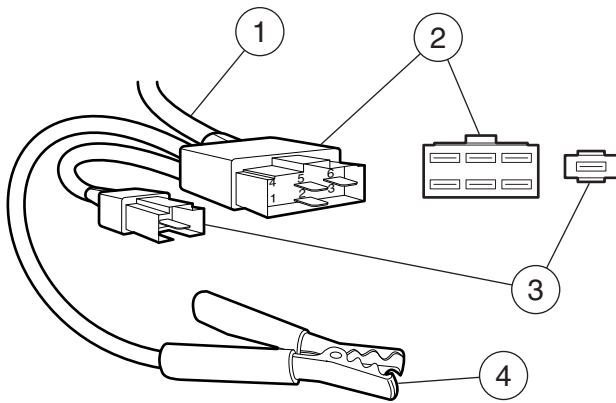

Cable Adapter 6-Pin MECS 7-0143

1. To scan tool
2. Vehicle DLC 6-Pin MECS
3. STI Pigtail
4. Clip to good vehicle ground

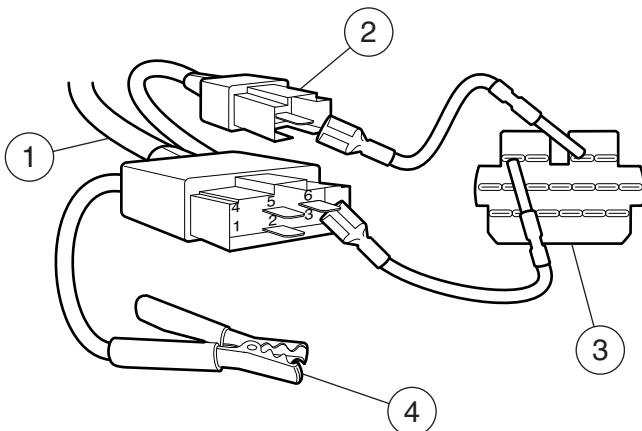

17-Pin MECS
Cable Adapter 6-Pin MECS 7-0143
Vehicle DLC 17-Pin MECS

1. To scan tool
2. STI Pigtail
3. STO
4. Clip to good vehicle ground



IMPORTANT

Certain Ford Probes have a WHITE TACH CONNECTOR located very close to the 6-pin self-test connector and bundled in the same wiring harness. This is not the Self-Test Input (STI) pigtail.

Connect the pigtail to the black STI connector located farther back on the wire harness. If the tool is con-

nected to the white tach connector, serious damage may result and may void warranty. Refer to the illustration.

GM (OBD I)

Prior to 1996, most GM vehicles used the 12-pin Assembly Line Diagnostic Link (ALDL) DLC. In 1994 and 1995, certain GM vehicles used the J1962 (OBD II) DLC, but are not OBD II compliant. After vehicle selection, the scan tool will indicate which cable is required.

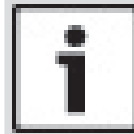

IMPORTANT

Use the included cigarette lighter cable (7-0135) to provide 12V to the tool only on vehicles requiring the OBD I DLC.

The ALDL DLCs are usually located under the dashboard on the driver's side. On Corvettes and Fieros, the DLC may be located in the center console behind the ashtray. Refer to service manual for exact location. It may be in full view, or it may be recessed behind a panel. An opening in the panel should allow access to the recessed connector.

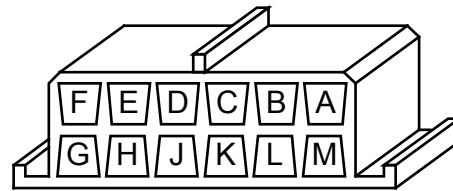

ALDL (P/N 7-0139)

Chrysler (OBD I)

Prior to 1996, most Chrysler vehicles used either the serial communications interface (SCI) or LH DLC. After vehicle selection, the scan tool will indicate which cable is required.

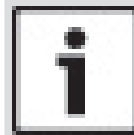

IMPORTANT

Use the included cigarette lighter cable (7-0135) to provide 12V to the tool when using the SCI adapter cable.

Serial Communication Interface (SCI)

The SCI DLC is a 6-pin connector located in the engine compartment. The adapter cable to be used on these vehicles is supplied with the tool. This cable is labeled CHRY SCI on the vehicle end and is included with the scan tool.

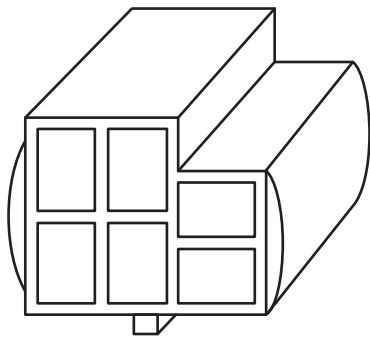

SCI (P/N 7-0141)

LH

This DLC is used on LH platform vehicles. The LH style DLC is a small, blue, rectangular 6-pin connector located in the passenger compartment below the dashboard to the right of the steering column. The LH Adapter Cable (7-0142) is optional and must be purchased separately.

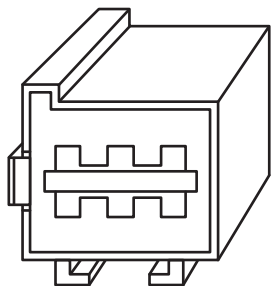

LH (P/N 7-0142)

Toyota (OBD I)

Prior to 1996, most Toyota vehicles used either a round or rectangular DLC. After vehicle selection, the scan tool will indicate which cable is required.

- The Toyota round DLC is a 17-pin connector located in the passenger compartment. This cable is labeled Toyota 2 on the vehicle end. The adapter cable (7-0146) is included with the scan tool.

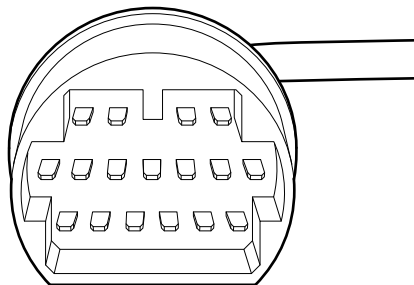

P/N 7-0146

- The Toyota rectangular DLC is a 20-pin connector located in the engine compartment. This cable is

labeled Toyota 1 on the vehicle end. The adapter cable (7-0145) is included with the scan tool.

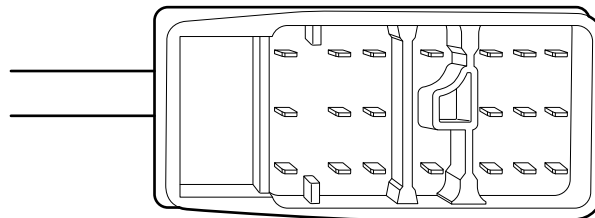

P/N 7-0145

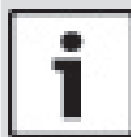

IMPORTANT

Use the included cigarette lighter cable (7-0135) to provide 12V to the tool when using either the Toyota round adapter cable or the Toyota rectangular adapter cable.

3.6 OBD II Diagnostic Trouble Codes (DTCs)

J2012 and ISO 15031-6 are standards for all DTCs, established by the SAE, International Organization for Standardization (ISO) and other governing bodies.

- Codes and definitions assigned by these specifications are known as Generic OBD II codes.
- OBD II requires compliance to these standards for all cars, light trucks, APVs, MPVs, and SUVs sold in the United States.
- Codes not reserved by the SAE are reserved for the manufacturer and referred to as Manufacturer Specific Codes.

DTCs are used to help determine the cause of a problem or problems with a vehicle.

- DTCs consist of a five-digit alphanumeric code.
- The DTCs format and general code types are shown below.

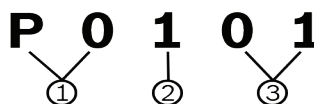

1. Bx = Body
Cx = Chassis
Px = Powertrain
Ux = Network communication
x = 0, 1, 2, or 3
2. Vehicle specific system
3. Specific fault designation

Example:

P0101 = Mass or volume air flow circuit range/performance problem

Powertrain Codes

Code	Type
P0xxx	Generic (SAE)
P1xxx	Manufacturer specific
P2xxx	Generic (SAE)
P30xx–P33xx	Manufacturer specific
P34xx–P39xx	Generic (SAE)

Chassis Codes

Code	Type
C0xxx	Generic (SAE)
C1xxx	Manufacturer specific
C2xxx	Manufacturer specific
C3xxx	Generic (SAE)

Body Codes

Code	Type
B0xxx	Generic (SAE)
B1xxx	Manufacturer specific
B2xxx	Manufacturer specific
B3xxx	Generic (SAE)

Network Communication Codes

Code	Type
U0xxx	Generic (SAE)
U1xxx	Manufacturer specific
U2xxx	Manufacturer specific
U3xxx	Generic (SAE)

4 Using the Scan Tool

4.1 The Scan Tool



1. USB port - provides USB connection for the computer.
2. **CODE CONNECT** **CodeConnect**® allows the operator to access vehicle-specific repair information.
3. **LEFT** and **RIGHT** arrow keys - selects YES or NO and selects data parameters for custom data list.
4. **ENTER** **ENTER** key - selects displayed items.
5. **ON/OFF** key - turns power ON or OFF.
6. **BACK** **BACK** key - goes to the previous screen or level.
7. **MORE INFO** key - displays the Diagnostic Trouble Code (DTC) definition when viewing Freeze Frame Data. It will display the code setting criteria when viewing DTC definition.
8. **UP** and **DOWN** arrow keys - moves selection up or down.
9. LCD display (color, backlit, QVGA resolution)
10. DLC cable (not shown) - provides connection for vehicle interface.
11. Serial Number Plate - Located inside battery compartment, provides serial number of scan tool.
12. Battery Compartment (on back; not shown) - provides power to the scan tool when reprogramming from a personal computer or off-vehicle reviewing of codes and printing.
13. 12V Power Jack (not shown) - provides power to scan tool when scan tool is connected to certain OBD I vehicles.

4.2 Specifications

Display	Color, backlit, QVGA resolution
Operating Temperature	0 to 50°C (32 to 122°F)
Storage Temperature	-20 to 70°C (-4 to 158°F)
Internal Power	4-AAA Batteries
External Power	7 to 16 Volts

A minimum of 8.0 V is required for most control modules to operate properly in a vehicle.

Dimensions

Height	Width	Depth
7 inches	3.75 inches	1.125 inches
178 mm	95 mm	29 mm

Accessories

Part	Description	Part No.
Extender Cable	Cable used to connect vehicle specific adapter cables to scan tool	7-0137
OBD II Cable	Communicates between vehicle and tool	7-0138
Ford OBD I EEC-IV Cable	Refer to page 9	7-0140
GM OBD I ALDL Cable	Refer to page 10	7-0139
Chrysler OBD I SCI cable	Refer to page 10	7-0141
Cigarette Lighter Cable	Cable used to power scan tool from cigarette lighter. Needed for OBD I Vehicles	7-0135
Toyota OBD I Rectangular Cable	Refer to page 11	(7-0145)
Toyota OBD I Round Cable	Refer to page 11	(7-0146)







Optional Accessories

Part	Description	Part No.
Battery Clip Y Adapter Cable	Adapter that allows the Cigarette Lighter Cable to connect directly to vehicle battery cables	7-0136
Ford OBD I MECS Cable	Refer to page 9	7-0143
Chrysler OBD I LH cable	Refer to page 11	7-0142

Replacement parts are available from the manufacturer by contacting customer service at 1-800-228-7667 (8:00-6:00 EST Monday-Friday).

4.3 Display

The display has a large viewing area for displaying messages, instructions, and diagnostic information. The back-lit liquid crystal display (LCD) is a QVGA pixel display. Display icons used to help operate the scan tool are:

- ↓ Indicates additional information is available by scrolling down.
- ↑ Indicates additional information is available by scrolling up.
-  Indicates the internal batteries need replaced or are not installed.
- √ Indicates selected items in a data list or that data is available for items on the Review Data and Print Data Menu.
-  indicates the  key is active.
-  Indicates graphical viewing of data items is available in View Data and when playing back previously recorded data.
-  indicates the  key is active.

Keypad

The keypad is used to move through the different menus of the scan tool. The scan tool's software is designed for ease in operating and navigating through menus.



CAUTION

Do not use solvents such as alcohol to clean keypad or display. Use a mild nonabrasive detergent and a soft, cotton cloth.





CAUTION

Do not soak keypad as water might find its way inside the scan tool.

4.4 Power

Internal Battery Power

- Battery power is not required to use tool.
- Press and hold  **ON/OFF** key for at least 1 second to turn ON scan tool.
- The scan tool will automatically turn OFF after a user-selectable period of inactivity when powered from the internal batteries. The default is 2 minutes.
- When powered from the internal batteries, the scan tool will dim display backlighting.
- The scan tool must be attached to the vehicle to perform diagnostic functions. The scan tool disables the diagnostic functions when powered from the internal batteries.
- Each time the scan tool is powered up, voltage of the internal battery is checked. If voltage is low, the Low Battery symbol () displays on screen. Replace the battery using instruction provided in Battery Replacement.

**CAUTION**

If the scan tool will not be used for an extended period of time, remove the batteries to prevent battery leakage from damaging the battery compartment.

Vehicle Power

When the scan tool is connected to the vehicle's DLC using the OBD II adapter cable, the tool is powered by the vehicle and will automatically turn on once connected. Some vehicle cigarette lighters are not powered when the ignition is in the OFF position. Therefore, you may wish to use the optional battery clip adapters (7-0136).

USB Power

When the tool is connected to a PC via a USB cable (not provided), the tool will automatically power up. Refer to "10.2 Scan Tool Does Not Power Up" on page 62 if there are problems.

4.5 System Setup

System Setup allows:

- Measurement units to be changed.
- Auto-Power off time to be changed.
- Printer Header to be turned ON or OFF.
- Scan tool information to be viewed.
- Display to be checked.
- Operation of the keypad to be checked.
- Memory of the tool to be checked.
- Scan tool to be upgraded.
- Language to be changed.
- Quick Test to be turned ON, OFF, or set to the desired method.
- Long PID names to be turned ON or OFF.
- Change the number of Pre-Trigger frames when recording data.

From the **Diagnostic menu**:

1. Select **System Setup**.
 - Use the ▲ **UP** and ▼ **DOWN** keys until **System Setup** is highlighted.
 - Press **ENTER**.

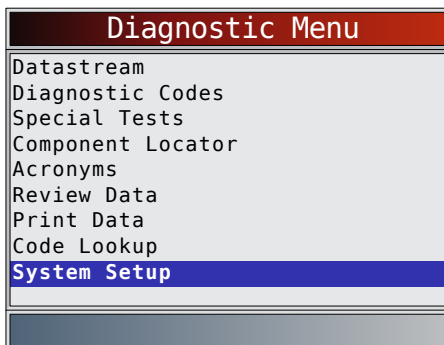
**Changing Measurement Units**

English is the default measurement unit. Measurement units can be changed in **View and Record Data**.

From **System Setup** menu:

1. Select **English/Metric**.
 - Use the ▲ **UP** and ▼ **DOWN** keys until **English/Metric** is highlighted.
 - Press **ENTER**.

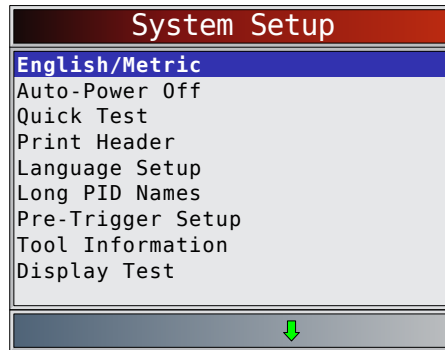

2. Select desired measurement unit.
 - Use the ▲ **UP** and ▼ **DOWN** keys until the desired unit is highlighted.
 - Press **ENTER**.

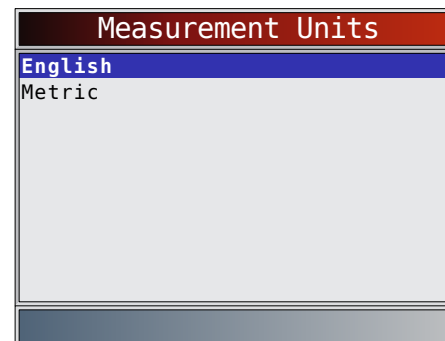

3. Save measurement setting.
 - Press **ENTER**.

Changing Auto-Power Off

The Auto-Power Off feature allows the tool to turn off automatically after a selected amount of time when tool is not being used. The Auto-Power Off feature will only turn the tool off when it is operating on battery power.

From **System Setup** menu:

1. Select **Auto-Power Off**.
 - Use the ▲ **UP** and ▼ **DOWN** keys until **Auto-Power Off** is highlighted.
 - Press **ENTER**.

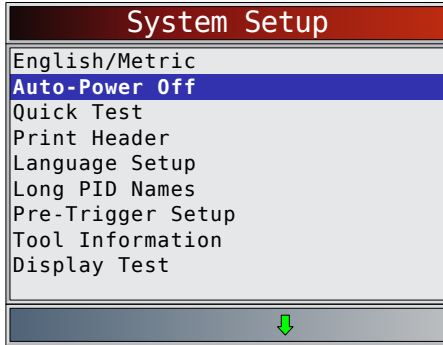

- Increase or Decrease **Auto-Power Off** time.
 - Use the ▲ **UP** key to increase time.
 - Use the ▼ **DOWN** key to decrease time.
 - Press **ENTER**.

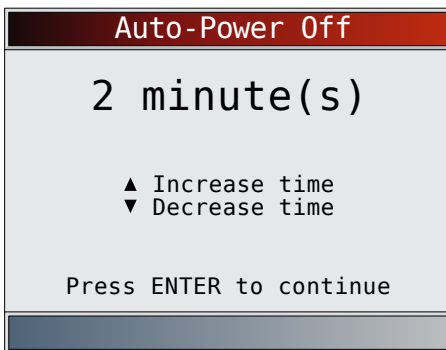

- Save **Auto-Power Off** time.
 - Press **ENTER**.

Quick Test

Quick Test is a feature of the tool that occurs the first time the tool establishes communication with the vehicle after vehicle selection. Quick Test will display the results of I/M Monitors and Read Codes. Quick Test will not be run for Ford OBD I and Toyota OBD I vehicles regardless of whether the setting is ON or OFF.

From **System Setup** menu:

- Select **Quick Test**.
 - Use the ▲ **UP** and ▼ **DOWN** keys until **Quick Test** is highlighted.
 - Press **ENTER**.

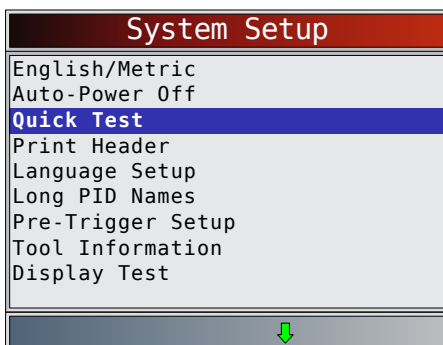

- Select desired **Quick Test** choice.

- Use the ▲ **UP** and ▼ **DOWN** keys until desired choice is highlighted.
- Select **QuickCheck™** to view the results of I/M Monitors and Read Codes.
- Select **Read All Codes** to view results of all codes and associated **CodeConnect®** information. This selection is enabled by default.

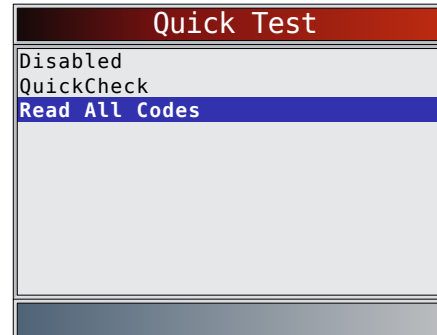

- Save **Quick Test** setting.
 - Press **ENTER**.

Print Header

Print Header selection allows the user to turn off the scan tool printing the currently-selected vehicle prior to the retrieved vehicle data when selecting items from the **Print Data** menu. For example, if your currently-selected vehicle is a 2008 Chevrolet Corvette W=6.2L, this information would print at the top of the page for the data you are printing.

From **System Setup** menu:

- Select **Print Header**.
 - Use the ▲ **UP** and ▼ **DOWN** keys until **Print Header** is highlighted.
 - Press **ENTER**.

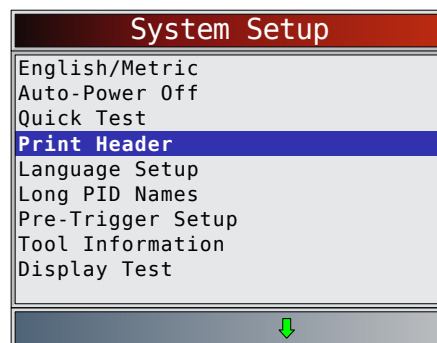

- Select desired **Print Header** choice.
 - Use the ▲ **UP** and ▼ **DOWN** keys until desired choice is highlighted.

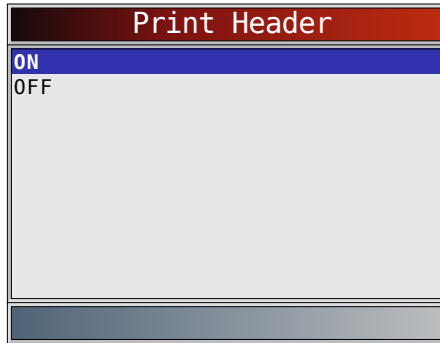

3. Save **Print Header** setting.
 - Press **ENTER**.

Language Setup

Language Setup selection allows the user to change the language used by the tool. English is the default language.

From **System Setup** menu:

1. Select **Language Setup**.
 - Use the **▲ UP** and **▼ DOWN** keys until **Language Setup** is highlighted.
 - Press **ENTER**.

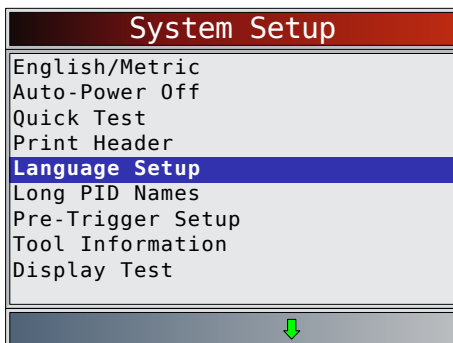

2. Select desired **Language Setup** choice.
 - Use the **▲ UP** and **▼ DOWN** keys until the desired language is highlighted.

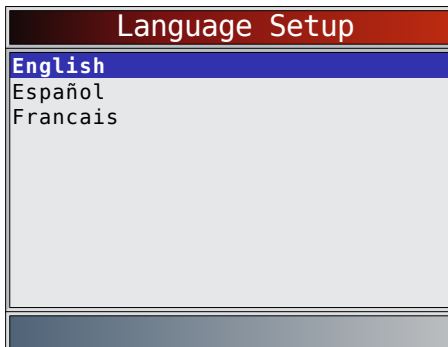

3. Save **Language Setup** setting.
 - Press **ENTER**.

NOTE: When Spanish or French translation is not known, English will be shown.

Long PID Names

Long PID Names allows the user to enable/disable the tool scrolling the complete PID name on the bottom line of the display while viewing Live Data or viewing Freeze Data. Long PID Names are not available on GM, Ford, Chrysler, and Toyota OBD I vehicles.

From **System Setup** menu:

1. Select **Long PID Names**.
 - Use the **▲ UP** and **▼ DOWN** keys until **Long PID Names** is highlighted.
 - Press **ENTER**.

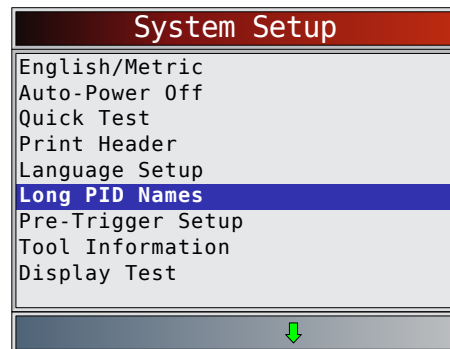

2. Select **ON** or **OFF**.
 - Use the **▲ UP** and **▼ DOWN** keys until the desired option is highlighted.
 - Press **ENTER**.

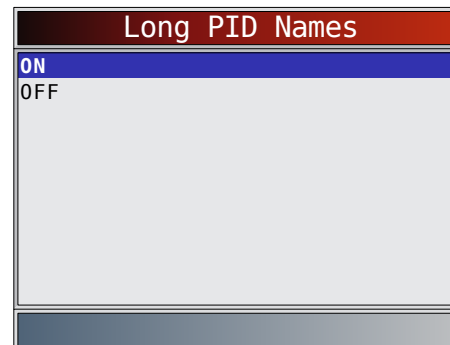

3. Save **Long PID Names** setting.
 - Press **ENTER**.

Pre-Trigger Setup

This function is used to configure how many Pre-Trigger frames are stored prior to beginning a recording. Pre-Trigger frames are the negative frames when you are playing back a recording.

From **System Setup** screen:

1. Select **Pre-Trigger Setup**.
 - Use the **▲ UP** and **▼ DOWN** keys until **Pre-Trigger Setup** is highlighted.
 - Press **ENTER**.

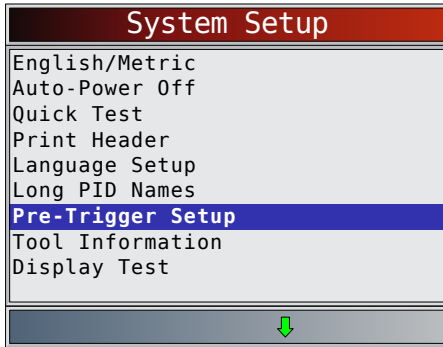

- Increase or Decrease Pre-Trigger Frames.
 - Use the ▲ **UP** key to increase frames.
 - Use the ▼ **DOWN** key to decrease frames.
 - Press **ENTER**.

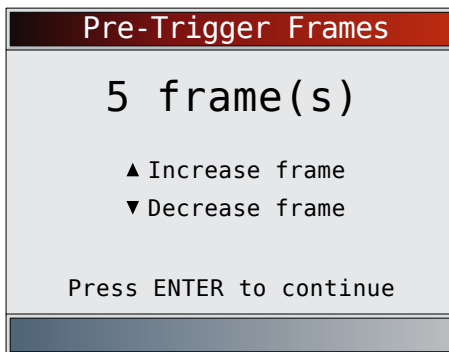

- Save **Pre-Trigger** frames setting.
 - Press **ENTER**.

Tool Information

Tool Information allows the user to view specific tool information that may be needed when contacting customer service.

From **System Setup** menu:

- Select **Tool Information**.
 - Use the ▲ **UP** and ▼ **DOWN** keys until **Tool Information** is highlighted.
 - Press **ENTER**.

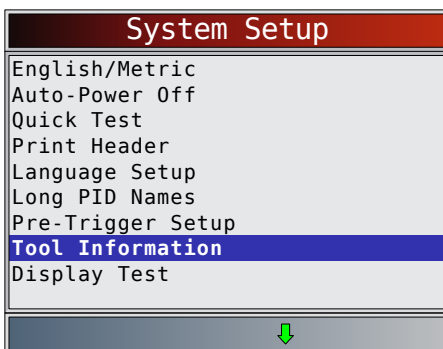

- View information.
 - Serial Number (Serial No:)
 - Software ID (SW ID:)
 - Hardware Version (HW Ver:)
 - Boot Version (Boot Ver:)

- Product ID (Prod ID:)
- Board ID (Board ID:)
- Burn Date (Burn Date:)
- Burn Location (Burn Loc:)

Tool Information	
Serial No	1284168
SW ID	5126
HW Ver	01
Boot Ver	02
Prod ID	21
Board ID	33
Burn Date	12/04/14
Burn Loc	04

- Record **Tool Information**.
 - Space is provided inside the front cover of this manual to write down the scan tool information.
- Return to **System Setup** menu.
 - Press **BACK**.
 - or
 - Press **ENTER**.

Display Test

The **Display Test** is used to check the display. The test fills every pixel of the display with a solid color.

From **System Setup** menu:

- Select **Display Test**.
 - Use the ▲ **UP** and ▼ **DOWN** keys until **Display Test** is highlighted.
 - Press **ENTER**.

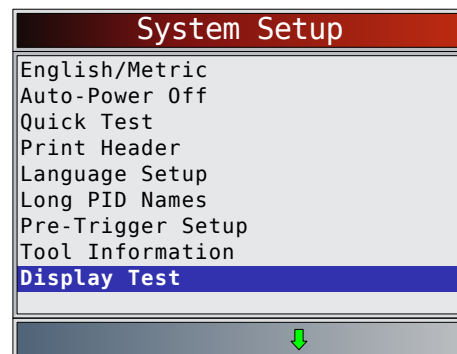

- Start **Display Test**.
 - Press **ENTER**.
- Look for missing spots.

- The first screen displayed says, “Check for missing spots in the display.”

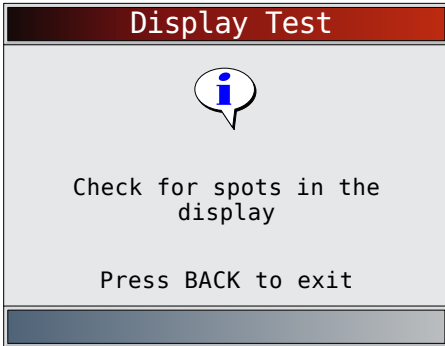

- Solid red, green, and blue screens are displayed.

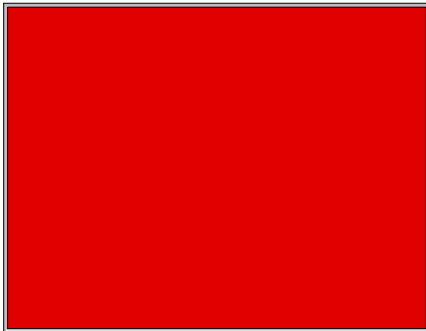

- These four screens will continue in succession until **BACK** is pressed.
- Press **BACK** to exit the test and return to the **System Setup** menu.

Keypad Test

The **Keypad Test** is used to verify that the keys are working correctly.

From **System Setup** menu:

- Select **Keypad Test**.
 - Use the **▲ UP** and **▼ DOWN** keys until **Keypad Test** is highlighted.
 - Press **ENTER**.

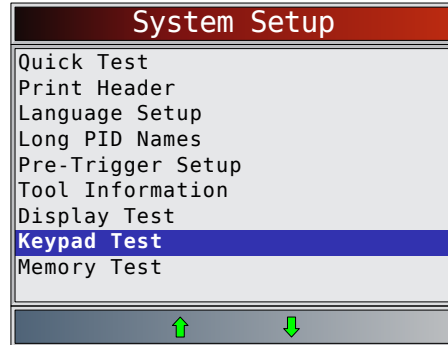

- Press a key.
 - Key name or scroll direction should inverse colors on display.
 - BACK** will return the tool to the **System Setup** screen. If **System Setup** screen does not return, **BACK** is not working correctly.



Memory Test

The **Memory Test** will test RAM and Flash ROM. Run the **Memory Test** if the tool has trouble:

- Playing back recorded data.
- Displaying trouble code definitions.

From **System Setup** menu:

- Select **Memory Test**.
 - Use the **▲ UP** and **▼ DOWN** keys until **Memory Test** is highlighted.
 - Press **ENTER**.

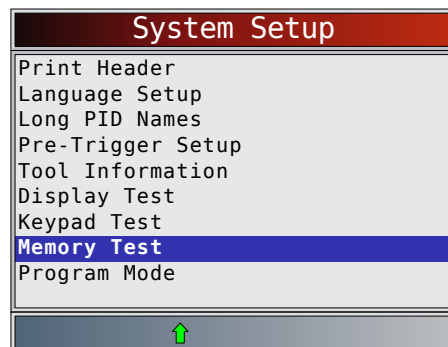

- **Memory Test** may take several minutes to complete.
- **Memory Test** results display:
 - If no problems were detected, then “Pass” is displayed.
 - If RAM fails, an error message is shown.
 - If FLASH fails, a checksum is shown.

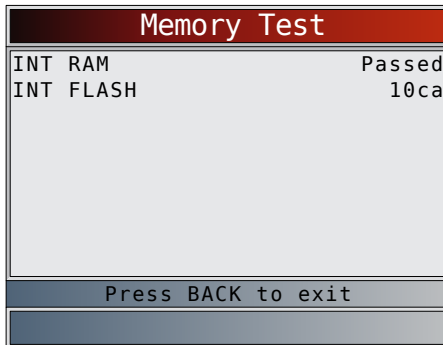

2. Return to **System Setup** menu.
 - Press **BACK**.

Program Mode

The **Program Mode** is used for updating the scan tool. Instructions are provided with upgrades. Refer to “3.2 Download Scanning Suite” on page 8.

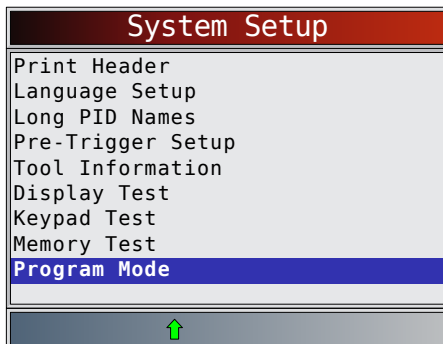

- If the **Program Mode** is entered, **BACK** is not operational. The tool must be powered off to exit **Program Mode** and then restarted to continue.

4.6 Vehicle-Specific Features

Review Data

The **Review Data** function allows the user to view the information from the previous vehicle tested. The scan tool can be powered from vehicle or PC using USB to use the **Review Data** function.

1. Select **Review Data**.
 - Use the **▲ UP** and **▼ DOWN** keys until **Review Data** is highlighted.
 - Press **ENTER**.

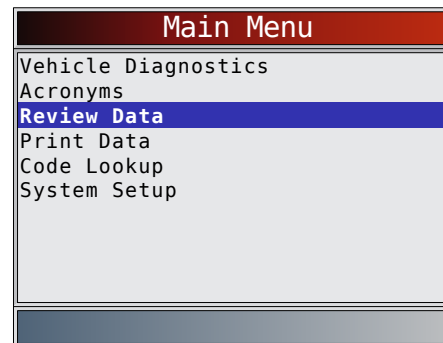

If Review Data is selected from the Main Menu, a Select Vehicle menu is shown. This menu contains up to 5 previous vehicles, so select which vehicle you wish to review data.

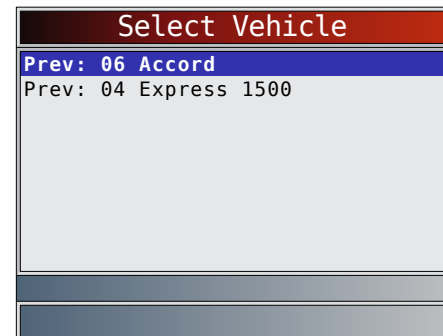

2. Follow prompts and instructions provided by scan tool and then select item whose data you wish to review.
 - The **Review Data** menu shows a checkmark next to the item(s) that has data.
 - If there is not a checkmark next to the item, then this item can't be selected until the appropriate function is run from the **Diagnostic Menu**.
 - Only one function, **Recording**, needs detailed instructions.

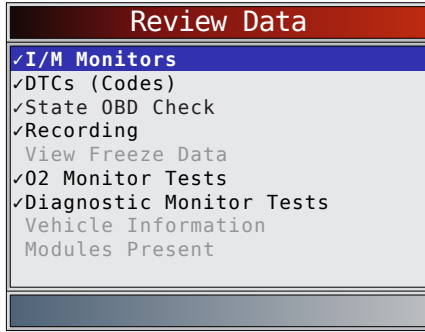

Recording

The **Recording** function is used to play back a recording. This function is very similar to **View Data**. The only difference is that **View Data** is real-time viewing of PIDs, while **Recording** is a viewing of previously recorded PIDs.

From the **Review Data** menu:

1. Select **Recording**.
 - Use the **▲ UP** and **▼ DOWN** keys until **Recording** is highlighted.
 - The tool can keep up to 5 recordings per vehicle. If the tool has more than one recording, select the recording you wish to playback.
 - Press **ENTER**.
2. Select **Playback Recording**.
 - Use the **▲ UP** and **▼ DOWN** keys until **Playback Recording** is highlighted.
 - Press **ENTER**.



- The recording has frame number and timestamp (in seconds).
 - Negative frames and timestamps indicate data recorded before trigger event.
 - Positive frames and timestamps indicate data recorded after trigger event.
 - Use the **▲ UP** and **▼ DOWN** keys to view recorded PID data within each frame.
 - Use the **◀ LEFT** and **▶ RIGHT** keys to scroll back and forth through frames.
 - Refer to “11 Appendix A—Global OBD II PID Definitions” on page 63.

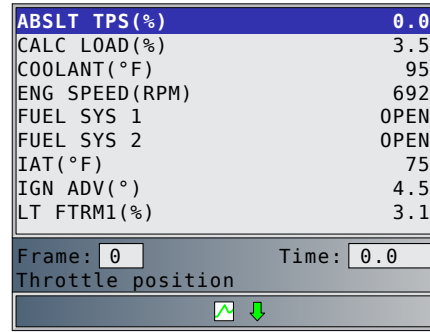

- If graphing is available for selected PID, the

“” icon is located on the side of the screen.

- Press **ENTER** to select PIDS to graph.
 - Use the **▲ UP** and **▼ DOWN** keys to highlight the second PID to graph and then press the **▶ RIGHT** key to select. A maximum of two PIDs can be graphed. Press **ENTER** to see graph.
 - Graphing is not available on GM, Ford, Chrysler, or Toyota OBD I vehicles.

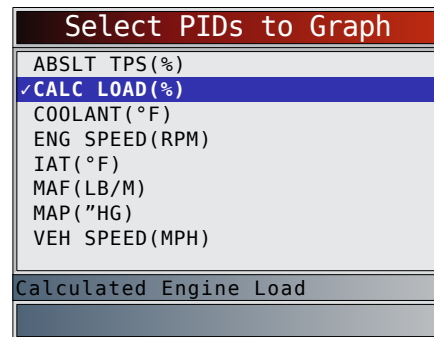

- The triangle below the graph indicates the position of the frame in the graph.
 - Use the **◀ LEFT** and **▶ RIGHT** keys to scroll back and forth through graph.
 - Use the **▲ UP** and **▼ DOWN** keys to toggle back and forth between PIDs.

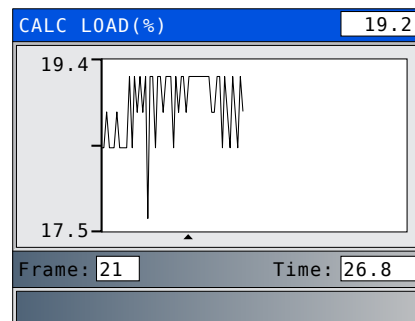

- Different vehicles communicate at different speeds and support a different number of PIDs. Therefore, the maximum number of frames that can be recorded varies.

3. Return to **Review Data** menu.

- Press **BACK**.

Print Data

The **Print Data** function allows the printing of diagnostic information stored in the scan tool.

- The scan tool's internal battery power can be used to print data.
 - Use the **Print Header** function to turn ON/OFF printing vehicle information prior to printing data.
 - Make sure you have precisely installed the PC software in Download Scanning Suite.
 - Launch Scanning Suite and then start printing application.
 - Follow all instructions on PC.
1. Select **Print Data**.
 - Use the ▲ **UP** and ▼ **DOWN** keys until **Print Data** is highlighted.
 - Press **ENTER**.

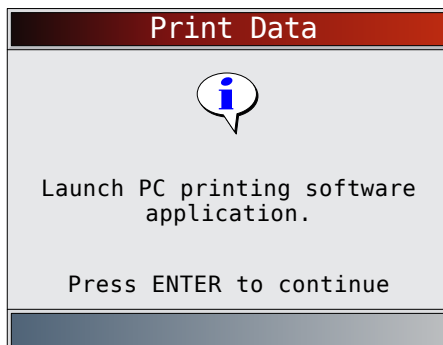
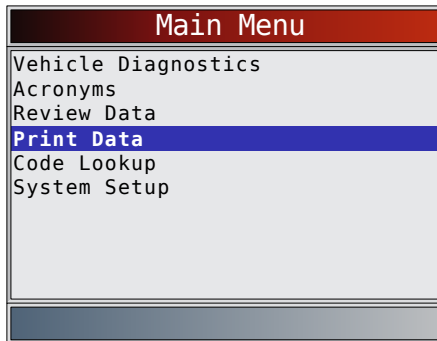

- On the **Print Data** menu, **Print All** prints all data collected by the scan tool.

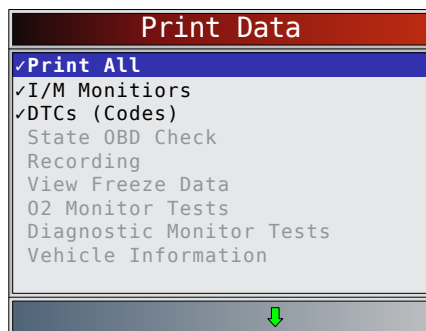

- When printing a recording, Start frame and end frame need to be defined.
- This menu contains up to 5 previous vehicles, so select which vehicle you wish to print data.

2. Select **Data To Be Printed**.
 - Use the ▲ **UP** and ▼ **DOWN** keys.
 - Press **ENTER**.
 - The **Print Data** menu shows a checkmark next to the items that have data.
 - If there isn't a checkmark next to the item, then this item can't be selected until the appropriate function is run from the Diagnostic Menu.
3. Return to **Select Print Data** screen.
 - Press **BACK**.

4.7 Code Lookup

Code Lookup is used to look up definitions of DTCs stored in the scan tool.

- The Code Lookup is selected from the Main Menu, the tool will display Vehicle Selection. Selecting a vehicle in Code Lookup from the Main Menu does not change the current (previously selected) vehicle. It is only a temporary change to allow you to lookup DTC for a vehicle other than the previous vehicle.
- When selecting Code Lookup from the Diagnostic Menu, the tool goes to the Select Module screen, if the selected vehicle supports more than one module. Select the desired module to access the Enter Code screen, since the vehicle was already selected.
- The scan tool does not require power from the vehicle to perform this function.

From the **Main Menu**:

1. Select **Code Lookup**.
 - Use the ▲ **UP** and ▼ **DOWN** keys until **Code Lookup** is highlighted.
 - Press **ENTER**.

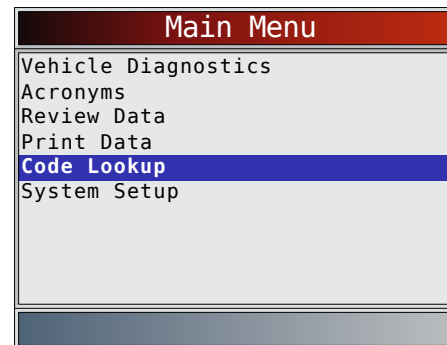

2. Select a specific vehicle from US, Europe, or Asia. If the vehicle is not in the list from the locations listed, select OBD II/EOBD.
 - To select a specific vehicle, refer to "4.10 Vehicle Selection" on page 22.

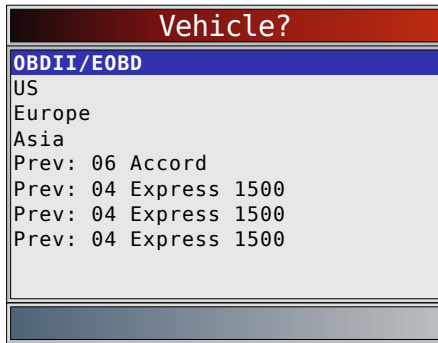

3. Enter code.
 - All characters must be entered.
 - Only one character can be changed at a time.
 - Use the ◀ **LEFT** and ▶ **RIGHT** keys to scroll to desired digit.
 - Use the ▲ **UP** and ▼ **DOWN** keys to change the selected digit.
 - Press **ENTER**.

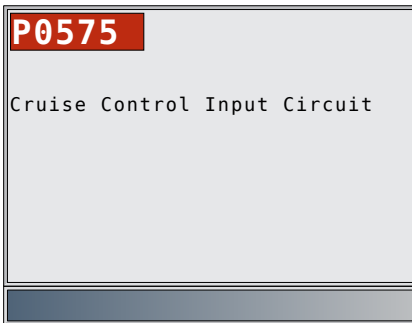
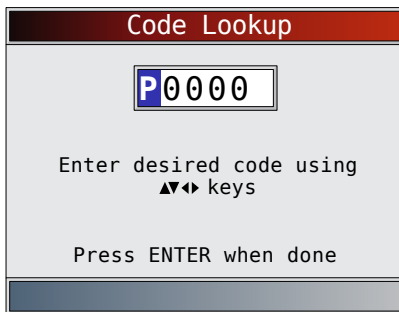

- Some vehicles may have an additional screen asking in which system to look for a code.
- If the definition could not be found, the scan tool displays “No DTC Definition Found.” Refer to Service Manual.

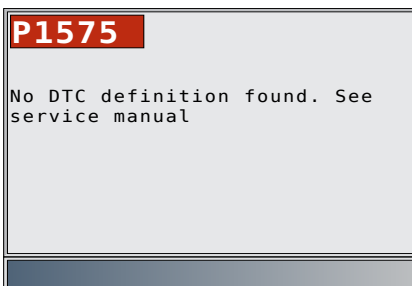

- On GM OBD I, Ford OBD I, and Chrysler vehicles the MIL (Blinky) code may also be entered.
4. To look up another DTC, press **BACK**.
 5. Press **BACK** again to return to the **Diagnostic Menu**.

4.8 Locating Data Link Connector

- The Data Link Connector (DLC) is usually located under the driver’s side dash for OBD II Vehicles and GM OBD I.
- For Ford, Chrysler, and Toyota OBD I Vehicles the (DLC) is usually found in the engine compartment.
- Refer to User’s Guide for DLC location and OBD I optional cables available for purchase.
- For more information on OBD II DLC locations, go to <http://www.obdclearinghouse.com/oemdb>.

NOTE: When using the OBD II cable, power to the tool comes from the vehicle.

4.9 Connect the Tool

1. Connect Data Link Connector cable to the tool.
2. Connect Data Link Connector to vehicle.
3. Connect cigarette lighter cable if needed.
4. Place ignition key in the ON position and have the engine running or OFF.
5. Select **Vehicle Diagnostics** from **Main Menu**.
6. Select **AutoID** for model year 2000 and newer vehicles. If the vehicle doesn’t support **AutoID** than **Manual** vehicle selection will automatically be entered. The tool can support up to 5 previous vehicles in the garage and the tool will display them on the menu after **Manual**. If you already have 5 vehicles in your garage, the tool will display a menu asking you which previous vehicle to replace with the currently identified vehicle.
7. After vehicle selection has been completed, press **ENTER** to continue on to review the Quick Test Results, if applicable.
8. Go to the **Diagnostic Menu** by pressing **ENTER**.

4.10 Vehicle Selection

AutoID™ uses the VIN to determine the type of vehicle the tool is connected to. Vehicle manufactures began programming the VIN into the vehicle controller in 2000, but it was not an OBD II mandate until 2005. Vehicles between 2000 and 2004 may or may not support AutoID™, but vehicles after 2005 should support AutoID™. If the tool is on a vehicle newer than database coverage, the tool will AutoID™ as MY OBD II/EOBD, or 2012 OBD II/EOBD.

From the **Main Menu**:

1. Select **Vehicle Diagnostics**.
 - Use the ▲ **UP** and ▼ **DOWN** keys until **Vehicle Diagnostics** is highlighted.
 - Press **ENTER**.

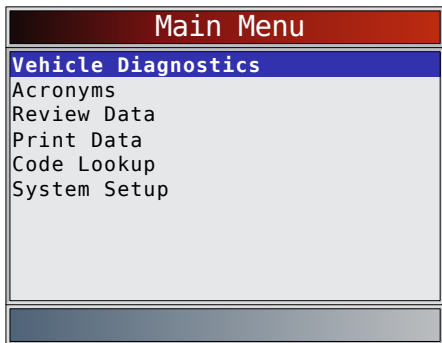

2. Use the ▲ UP and ▼ DOWN keys to select **AutoID™, Manual, or Prev.:**
 - If the vehicle is a model year 2000 or newer, select **AutoID**.
 - If the vehicle is 1999 or older, or if the vehicle is 2000 to 2004 but does not support AutoID™, select **Manual** and go to Step 3.
 - If the previously tested vehicle listed after **Prev:** is desired, select **Prev:**. If this is the first time the tool has been used, the space after **Prev:** will be blank.

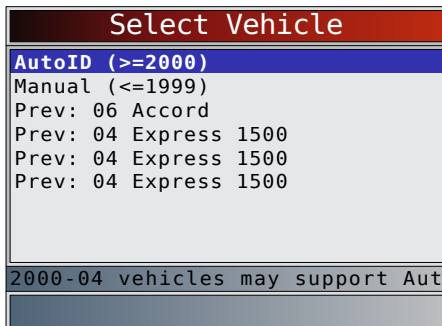

- Press **ENTER**.
- A **Turn Key Off** screen will display.

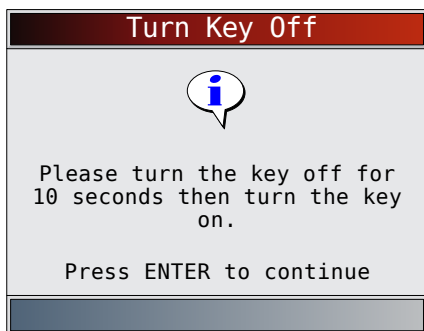

3. After 10 seconds, turn key ON.
 - If the vehicle is supported, the VIN number and essential vehicle data will display.
4. Use the ◀ LEFT and ▶ RIGHT keys to select YES or NO.
 - If YES is selected, the Tool may display more selections to further select the vehicle because not every aspect of vehicle identification is contained in the VIN.
 - If NO is selected, the Tool proceeds to manual selection.

- Press **ENTER**.

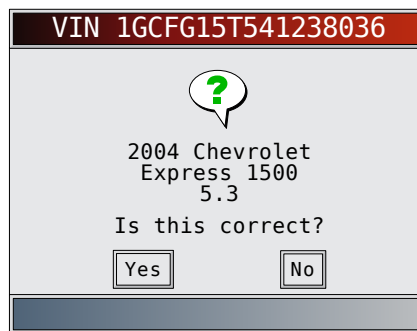

5. If **Manual** was selected in Step 2, use the ▲ UP and ▼ DOWN keys to select:
 - **OBD II/EOBD**
 - **US**
 - **Europe**
 - **Asia**
 - **Previous vehicle**
 - Press **ENTER**.

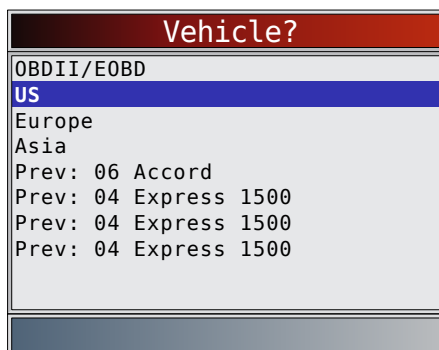

The OBD II/EOBD selection is provided for vehicles that are not listed, however, selection of the specific vehicle is recommended for maximum tool utility. The previously selected vehicle will appear as the **Prev:** menu selection after **Asia**.

- To select a vehicle other than the previous vehicle, choose between OBD II/EOBD, US, Europe, or Asia, and continue making selections until the vehicle selection is complete.

The following screen only displays when power comes from vehicle.

- Turn vehicle key OFF for 10 seconds.
- Turn vehicle key back to the ON position.
- Press **ENTER**.

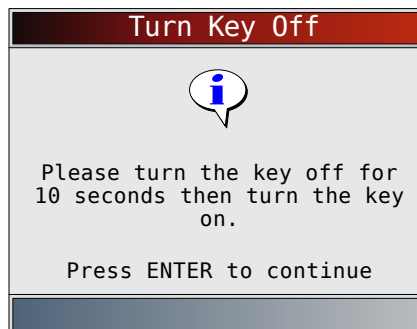

- If vehicle power is not detected, a screen is shown to verify tool connection.



- If you already have 5 vehicles in your garage, the tool will display a menu asking you which previous vehicle to replace with the currently identified vehicle.

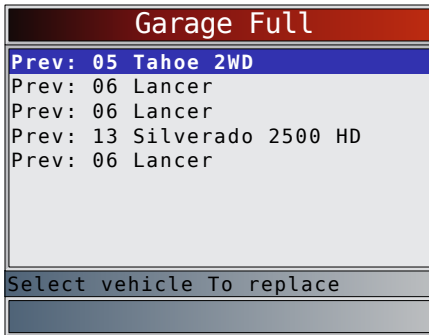

- If the previous vehicle is selected, all stored vehicle data will be retained until it is overwritten by the corresponding function selected from the **Diagnostic Menu**.

4.11 CodeConnect® Feature

CodeConnect® is an experience-based database derived from millions of phone calls from technicians seeking assistance diagnosing repair problems on their vehicles. **CodeConnect®** brings the technology of professional technicians to a DIY scan tool. Don't waste time trying to find the answer. With the information **CodeConnect®** offers, it takes vehicle repairs to the next level. Since you now know the most probable fix for your problem, you can decide if you want to tackle the repair yourself, or bring the vehicle to a local automotive repair facility.

IMPORTANT





In order for CodeConnect® to work, you must select your specific vehicle during vehicle selection. A Global OBD II vehicle selection will not provide any CodeConnect® information. The power of CodeConnect® is that repair information is vehicle and trouble code specific and is based on the largest experience-based database available.

CodeConnect® information is available whenever  is visible on the display. It has the potential of being

displayed while trouble codes are being displayed from Read Codes or while viewing Freeze Frame data. Also, when you print codes to your PC, the **CodeConnect®** information, if available, will also be printed.

- **CodeConnect®** information is currently only available in English, so if your tool is set to Spanish or French, don't be alarmed if your DTC text is in one language and your **CodeConnect®** information is shown in English.
- **CodeConnect®** is not available on GM, Ford, Chrysler, and Toyota OBD I vehicles.

How to use **CodeConnect®**:

1. When the  CodeConnect® icon is shown on the display, press  **CodeConnect®**.
2. Scroll through the code-specific repair information.
 - Use **▲ UP** and **▼ DOWN** keys to scroll one line at a time.
 - Use the **◀ LEFT** and **▶ RIGHT** keys to scroll one screen at a time.

There are 3 levels of reported fixes:

Fix Level	Description
Top Reported Fix	More likely to be the solution over other choices provided
Frequently Reported Fix	As likely as other solutions
Also Reported Fix	Less likely than other solutions provided, but worth considering.

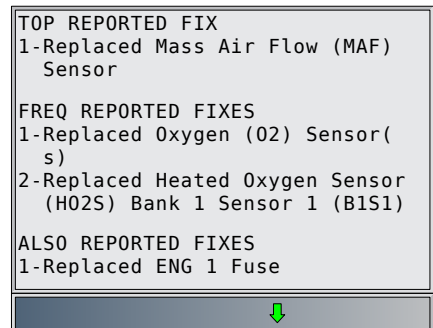
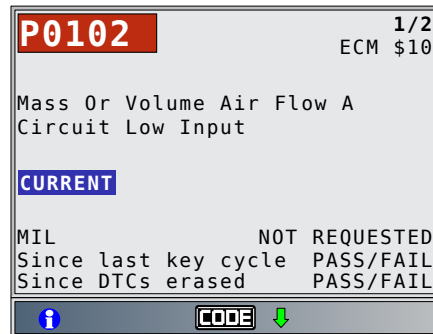

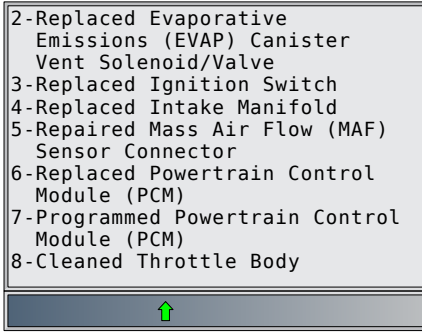

3. To return to the screen from which you pressed the





4.12 Code Criteria

The **Code Criteria** feature will detail the conditions required for a DTC to be set by the vehicle. The vehicle is constantly running self-tests on its systems. **Code Criteria** will describe the conditions under which the vehicle can initiate the test. These are called “Enable” criterion. **Code Criteria** will also describe the the conditions that will cause a DTC to set. These are called “Failure” criterion. **Code Criteria** is not available for every DTC.

- **Code Criteria** is currently only available in English, so if your tool is set to Spanish or French, don't be alarmed if your DTC text is in one language and your **Code Criteria** information is shown in English.
- **Code Criteria** is not available on GM, Ford, Chrysler, and Toyota OBD I vehicles.

How to use **Code Criteria**:

1. When the  icon is shown on the display, press the  key.
2. Scroll through the Code Criteria information. If a vehicle has multiple sets of criteria for the DTC, a menu is displayed so that the tool can provide the most accurate criteria for your specific vehicle.
3. Use the **▲ UP** and **▼ DOWN** keys to scroll one line at a time.
4. Use the **◀ LEFT** and **▶ RIGHT** keys to scroll a whole screen at a time.
 - To return to the DTC definition screen, press

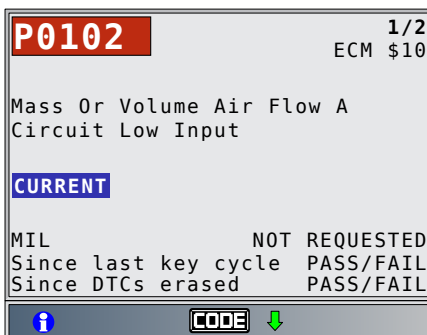

4.13 Acronyms

The **Acronyms** function allows the user to view acronyms and abbreviations used by the scan tool.

From the **Main Menu** or **Diagnostic Menu**:

1. Select **Acronyms**.
 - Use the **▲ UP** and **▼ DOWN** keys until **Acronyms** is highlighted.
 - Press .

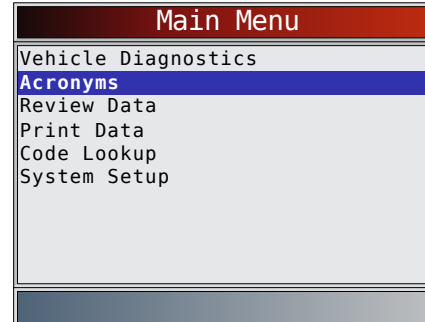

2. Select the alphabetical group range for the desired acronym.

- Use the **▲ UP** and **▼ DOWN** keys until the desired group range is highlighted.
- Press .

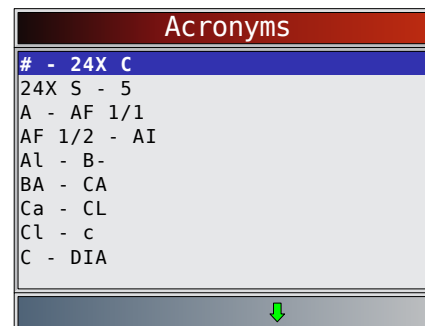

3. Select the acronym.

- Use the **▲ UP** and **▼ DOWN** keys until the desired acronym is highlighted.
- Press .

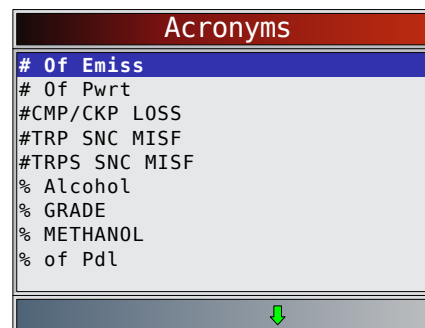

4. View selected acronym.

- Press  to return to the **Diagnostic Menu**.

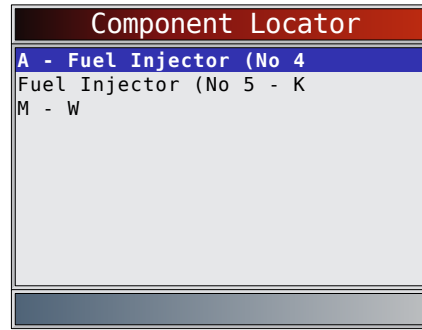
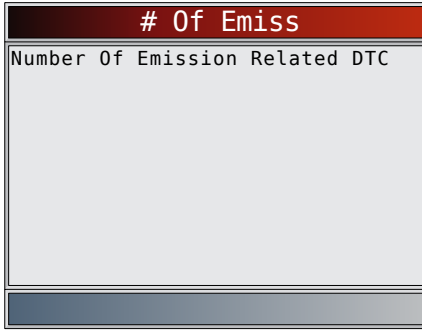

4.14 Component Locator

Component Locator provides a vehicle-specific location of components found on the selected vehicle. It is a useful companion function to **CodeConnect®**. **CodeConnect®** will indicate components that repaired a problem associated with a DTC, and **Component Locator** provides the location of the component.

Component Locator can be selected from the **Diagnostic Menu**. Since **Component Locator** provides vehicle-specific component locations, a previous vehicle must be stored in the scan tool.

Component Locator is not available on GM, Ford, Chrysler, and Toyota OBD I vehicles.

From the **Diagnostic Menu**:

1. Select **Component Locator**.
 - Use the ▲ **UP** and ▼ **DOWN** keys until **Component Locator** is highlighted.
 - Press **ENTER**.

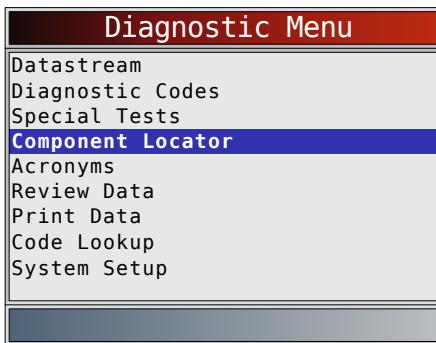

2. Select the alphabetical group range for the desired component.
 - Use the ▲ **UP** and ▼ **DOWN** keys until the desired group range is highlighted.
 - Press **ENTER**.

3. Select the component.
 - Use the ▲ **UP** and ▼ **DOWN** keys until the desired component is highlighted.
 - Full component name will scroll on bottom of screen for the highlighted component
 - Press **ENTER**.

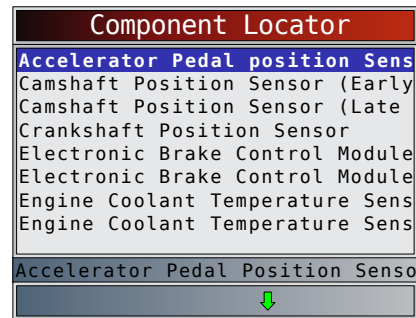

4. View selected component location.
 - Press **ENTER** to return to the **Diagnostic Menu**.

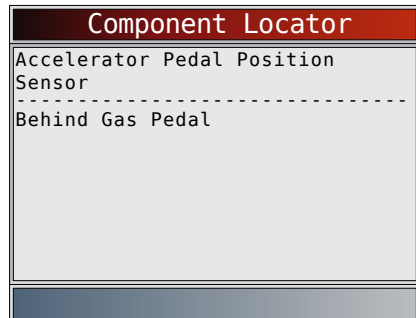

5 OBD II Diagnostics

This section applies to all Global OBD II compliant vehicles. It also covers manufacturer specific diagnostics for GM, Ford, Chrysler, Toyota, Honda, Nissan, and Hyundai. The first time the scan tool links to the vehicle, the communication protocol is automatically detected, and is used until the scan tool is turned off or another vehicle is diagnosed.

If an error message displays, make sure the OBD II connector is attached and the ignition key is on. Cycle ignition key to OFF for 10 seconds, then ON. This may be required to reset computer. If required, select YES to try again. If problem still exists, refer to "10.1 Error Messages" on page 61.

The scan tool keeps data received from the previous 5 vehicle's selected until any of the following occurs:

- A new vehicle is selected when you already have 5 in your garage forcing you to select which vehicle you want to remove from your garage to create space.
- Scan tool is flash programmed to update software.

On initial link to vehicle, scan tool checks the status of I/M Monitors no matter which function is selected.



IMPORTANT

Review Data, Print Data, Code Lookup, Component Locator, Acronyms and System Setup are covered in Section 5 of this manual. These items are not covered in this section.

The **Diagnostic Menu** is broken down into the following selections:

- Datastream
 - View Data
 - Record Data
 - Component Locator
 - Acronyms
 - Review Data
 - Print Data
 - Code Lookup
 - System Setup
- Diagnostic Codes
 - Read Codes
 - Erase Codes
 - View Freeze Data
 - Component Locator
 - Acronyms
 - Review Data
 - Print Data
 - Code Lookup
 - System Setup
- Special Tests
 - I/M Monitors
 - Drive Cycle Monitor
 - State OBD Check
 - MIL Status
 - O2 Monitor Tests
 - Diagnostic Monitor Tests
 - On-Board Systems
 - Vehicle Information
 - Oil Light Reset
 - Battery Reset
 - Charging System Monitor
 - Modules Present
 - Component Locator
 - Acronyms
 - Review Data
 - Print Data
 - Code Lookup
 - System Setup
- Component Locator
- Acronyms
- Review Data

- Print Data
- Code Lookup
- System Setup

Not every function will be on the menus for every vehicle. Some functions are vehicle specific, so they will not appear on every menu.

5.1 I/M Monitors (Emissions)

The **I/M Monitors** (Inspection / Maintenance) function is used to view a snapshot of the operations for the emission system on OBD II vehicles. **I/M Monitors** is a very useful function. To guarantee no faults exist make sure all monitors are ok or n/a and no DTCs exist. Refer to the vehicles service manual for the drive cycle operation. During normal driving conditions, the vehicle computer scans the emission system. After a specific amount of drive time (each monitor has specific driving conditions and time required), the computer monitors decide if the vehicles emission system is working correctly or not as well as detecting out of range values. When the monitor status is:

- ok - vehicle was driven enough to complete the monitor.
- inc (Incomplete) - vehicle was not driven enough to complete the monitor.
- n/a (not applicable)- vehicle does not support that monitor.

Depending on vehicle, disconnecting or a discharged battery may erase DTCs and clear monitor status. Monitors may be reset by:

- Erasing codes
- Vehicle control modules losing power

The **I/M Monitors** function can be run key on engine running (KOER) or key on engine off (KOEO).

Extreme weather and/or road conditions can prevent a monitor from running. Also, some monitors may require a cold start to complete.

From the **Special Tests Menu**.

1. Select **I/M Monitors**.
 - Use the ▲ **UP** and ▼ **DOWN** keys until **I/M Monitors** is highlighted.
 - Press **ENTER**.

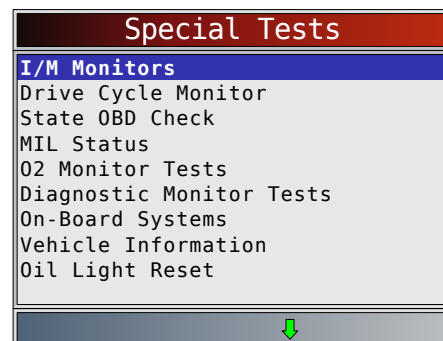

Two types of **I/M Monitors** test are:

- **Since DTCs Cleared** - shows status of the monitors since the DTCs were last erased.

- **This Drive Cycle** - shows status of monitors since the start of the current drive cycle. Refer to the vehicle service manual for more detailed information on emission-related monitors and their status. Some vehicles do not support **This Drive Cycle**. If vehicle supports both types of monitors the I/M Monitors Menu displays.

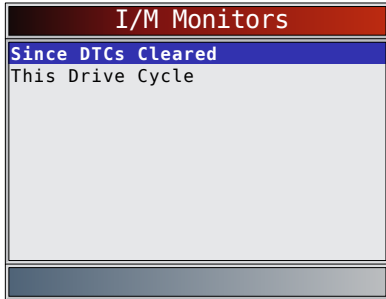

- View summary of monitor status.
 - Use the ▲ UP and ▼ DOWN keys (if required).
 Depending on monitor test, one of these two screens will be present.

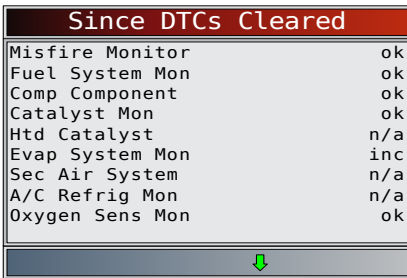

OR

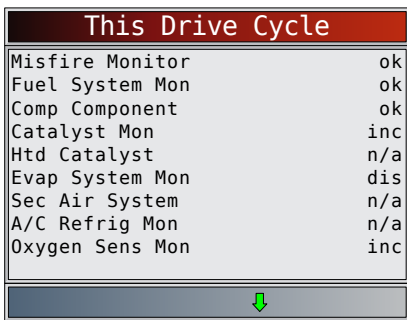

Abbreviations and names for OBD II monitors supported by the scan tool are shown below. They are required by the United States Environmental Protection Agency (EPA). Not all monitors are supported by all vehicles.

Monitors	Expanded Name
Misfire Monitor	Misfire monitor
Fuel System Mon	Fuel System Monitor
Comp Component	Comprehensive components monitor
Catalyst Mon	Catalyst monitor
Htd Catalyst	Heated catalyst monitor
Evap System Mon	Evaporative system monitor
Sec Air System	Secondary air system monitor
A/C Refrig Mon	Air conditioning refrigerant monitor
Oxygen Sens Mon	Oxygen sensor monitor

Oxygen Sens Htr	Oxygen sensor heater monitor
EGR/VT Sys Mon	Exhaust gas recirculation or variable valve timing monitor
NMHC Cat Mon	Non-methane hydrocarbon catalyst monitor
NOX Treat Mon	Nitrogen oxide treatment monitor
Boost Pres Mon	Boost pressure monitor
Exhst Gas Sensr	Exhaust gas sensor
PM Filter Mon	Particulate matter filter monitor

- Return to **Special Tests Menu**.
 - Press **BACK**.

5.2 Read Codes

The **Read Codes** function allows the scan tool to read the DTCs from the vehicle's control modules. DTCs are used to help determine the cause of a problem or problems with a vehicle. These codes cause the control module to illuminate the malfunction indicator lamp (MIL) when emission-related or driveability fault occurs. When referring to the engine control module, MIL is also known as service engine soon or check engine lamp. **Read Codes** can be done with the key on engine off (KOEO) or with the key on engine running (KOER).

From the **Diagnostic Codes Menu**:

- Select **Read Codes**.
 - Use the ▲ UP and ▼ DOWN keys until **Read Codes** is highlighted.
 - Press **ENTER**.

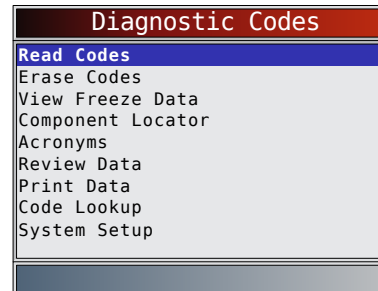

- If more than one module is supported, a menu is displayed.
 - Use the ▲ UP and ▼ DOWN keys until the desired choice is highlighted.
 - Press **ENTER**.

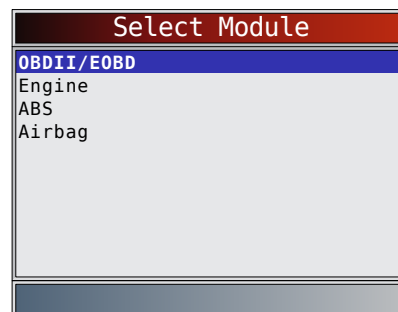

If no DTCs are present, a message stating “No codes found” is displayed. If **All of the Above** is selected from the **Select Module** menu, all of the codes will be displayed as if all menu items were selected individually.

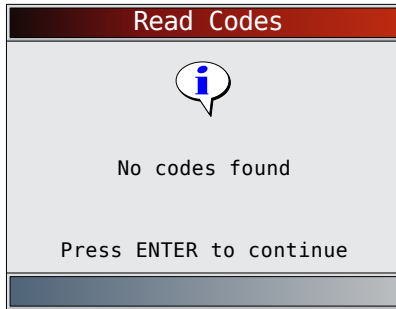

3. View and write down the DTCs.
 - Use the ▲ **UP** and ▼ **DOWN** keys until the desired choice is highlighted.

This screen indicates where the **Read Codes** information is located.

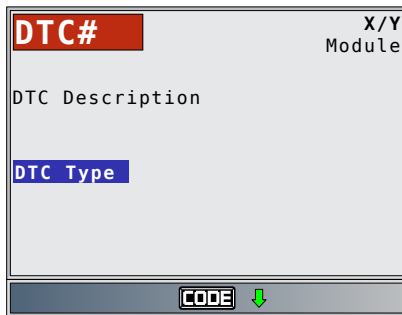

DTC Number - number of the trouble code found in vehicle service information.

X of Y - Indication that code x of y is being viewed, where x is the code being viewed of the total y.

Module - The name of the module (e.g. ABS) or address of the module (e.g. Mod \$28) or both are shown (ABS \$28) in this field. The table below describes modules supported.

Module	Description
ECM	Engine or powertrain module
TCM	Transmission control module
TCCM	Transfer case control module
ABS	Anti-lock brake system module
HPCM	Hybrid powertrain control module
MOD \$XX	Module address for the OBD II/EOBD module reporting the DTC
SRS	Supplemental restraint system module

DTC Description - This area is reserved for the text describing the trouble code listed in the DTC number field.

DTC Type - This area is reserved for providing additional information about the DTC. Multiple DTC types may be possible for a given DTC number. Not all vehicles support DTC types. This table describes possible DTC types.

DTC Type	Description
History	Intermittent codes placed in the vehicle's memory when the trouble originally occurred, and will remain there even if the trouble has been corrected. If no trouble after 50 engine warm-up cycles, the DTC will be erased.

Confirmed	Confirmed codes are reported when a component, sensor, or other part of the vehicle is indication a malfunction is present.
Current	Codes transmitted through the PCMs data stream when a trouble condition is active and cannot be erased. The problem must be repaired to remove the DTC.
Intermittent	Indicates the current code has been set at least once but possibly not enough to cause a history code to be stored.
MIL	Indicates that this DTC has turned on the MIL light.
Pending	Pending codes are also referred to as continuous monitor or maturing codes. An intermittent fault causes the control module to store a code in memory. If the fault does not occur within a certain number of warm-up cycles (depending on vehicle), the code clears from memory. If fault occurs a specific number of times, the code matures into a DTC and the MIL illuminates or blinks. This function can be used with KOEO or KOER.
Non-MIL	DTC that is not emission-related and did not turn on the MIL light.
MIL Code	This DTC type also has a number with it indicating that this is the code number turning on the MIL. Vehicle service manuals may refer to this number instead of the one listed in the DTC number field.
Permanent	Permanent codes are a special type of confirmed code. Permanent codes began being reported by vehicles around 2010, and therefore not supported by every vehicle. While Confirmed Codes can be erased by the Tool, Permanent Codes cannot. Permanent Codes are erased by the vehicle when the vehicle has determined the fault is no longer present.
SCI Hex	On some vehicles, the code returned by the vehicle is not known by the Scan Tool. If this happens, the Scan Tool will display this type along with the code number.
Active	DTC that was present at the time of scan tool request.
Stored	DTC that was not present at the time of scan tool request.

Examples of Read Codes information screens follow. In this example, module (MOD) \$18 is reporting the DTCs.

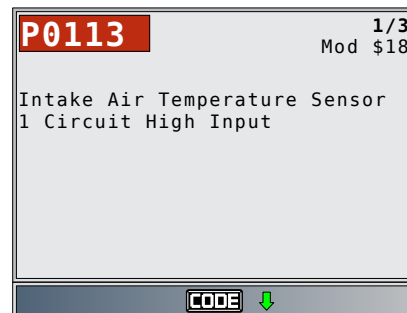

In this example, the Engine Module is reporting a History Code. The \$10 is the engine module address.

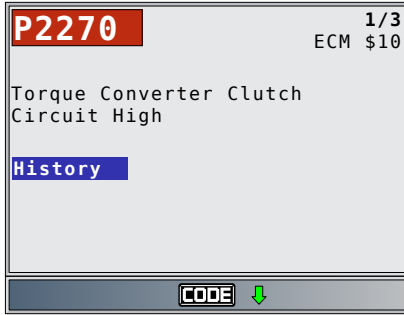

MIL indicates that this DTC has turned on the MIL light.

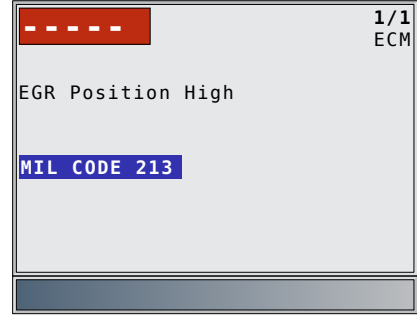

Active is a DTC that was present at the time of scan tool request.

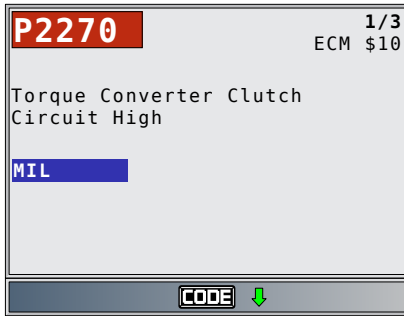

Pending indicates a global OBD II/EOBD pending code.

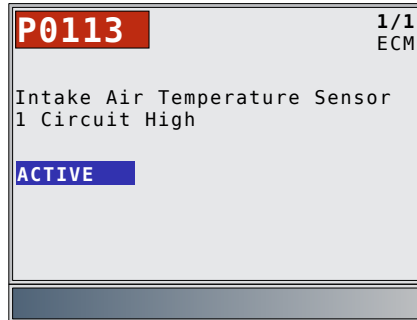

4. Return to **Diagnostic Codes Menu**.
 - Press **BACK**.

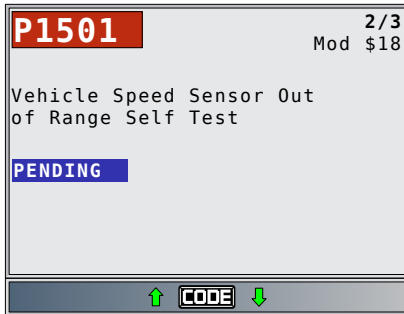

CODE icon indicates that the **CODE CONNECT** key is active. Press the **CODE CONNECT** key to display repair information. Refer to "4.11 CodeConnect® Feature" on page 24. Non-MIL is a DTC that is not emission-related and did not turn on the MIL light.

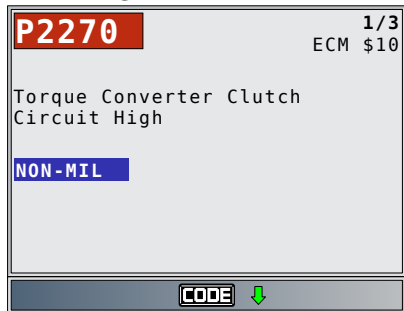

This screen shows dashes for the DTC number and a MIL code of 213. The dashes will be shown if a DTC number does not exist for the MIL code.

5.3 Erase Codes

The **Erase Codes** function deletes DTCs and resets I/M Monitor data from vehicle's control module(s). Perform this function key on engine off (KOEO). Do not start the engine.

The **Erase Codes** function may also erase View Freeze Data, O2 Monitor Tests, and Diagnostic Monitor Test results depending on vehicle.

The **Erase Codes** function sets monitors to inc.

Perform **Erase Codes** function only after systems have been checked completely and DTCs have been written down.

After servicing the vehicle, erase stored DTCs and verify no codes have returned. If a DTC returns, problem has not been fixed or other faults are present.

Permanent DTCs cannot be erased with the Erase Codes function.

Depending on which monitor sets a code, the vehicle may need to be driven and the monitor ran before concluding that the fault is repaired.

From **Diagnostic Codes Menu**:

1. Select **Erase Codes**.
 - Use the **▲ UP** and **▼ DOWN** keys until **Erase Codes** is highlighted.
 - Press **ENTER**.

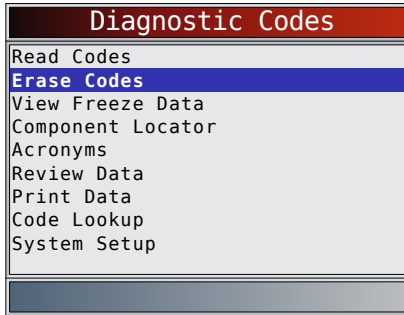

- If diagnostic results and codes are not to be erased select **NO** and press **ENTER**.

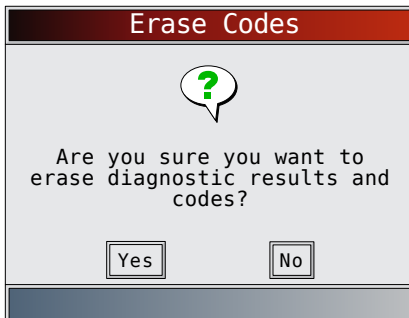

- Selecting **NO** displays a “Command canceled” message.

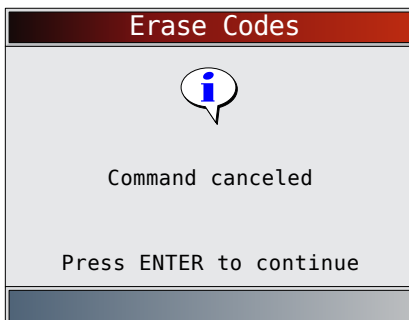

2. Select **YES** to erase diagnostic results and codes.
 - Use the **LEFT** arrow key.
 - Press **ENTER**.

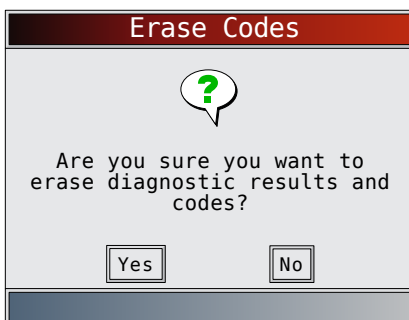

3. If more than one module is supported, a menu is displayed.
 - Use the **UP** and **DOWN** keys until the desired choice is highlighted.
 - Press **ENTER**.

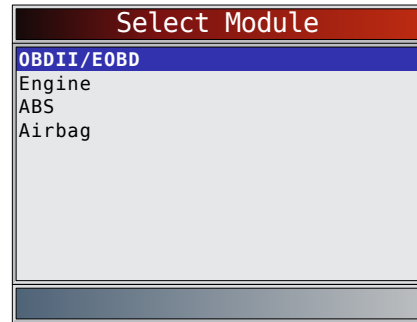

4. Observe “Command sent” message is displayed.
 - Press **ENTER**.

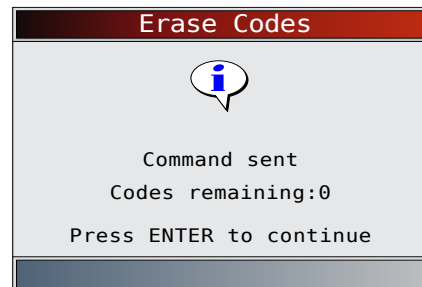

5. Return to **Diagnostic Codes Menu**.
 - Press **BACK**.

5.4 MIL Status

From **Special Tests Menu**:

1. Select **MIL Status**.
 - Use the **UP** and **DOWN** keys until **MIL Status** is highlighted.
 - Press **ENTER**.

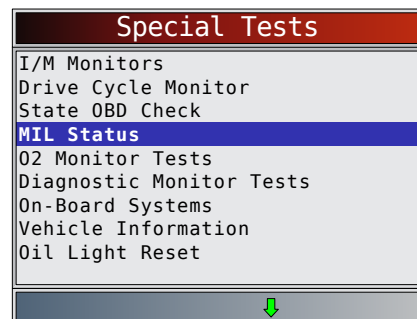

2. View **MIL Status**.
 - Press **ENTER** to return to **Special Tests Menu**.





5.5 State OBD Check

The **State OBD Check** function is used to display a basic status of the vehicle's OBD system.

- Malfunction indicator lamp (MIL) status
- Codes found
- I/M monitors

Erase Codes deletes DTCs and resets I/M monitors from vehicle's computer module(s).

The **State OBD Check** function has the following areas:

- MIL Status ON or OFF
- Number of Codes Found
- Number of Monitors OK
- Number of Monitors Inc
- Number of Monitors N/A

State OBD Check should be done with the key on engine running (KOER) due to showing MIL status.

The number of codes found are only Global OBD II codes and not pending codes.

The number of monitors that are either ok, inc, or na are only Since DTCs Cleared and not This Drive Cycle.

Refer to "5.1 I/M Monitors (Emissions)" on page 27 and "5.2 Read Codes" on page 28 for more detailed information about the results.

From **Special Tests Menu**:

1. Select **State OBD Check**.
 - Use the ▲ **UP** and ▼ **DOWN** keys until **State OBD Check** is highlighted.
 - Press **ENTER**.

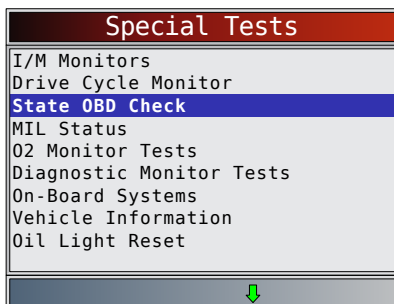

2. View **State OBD Check** display.

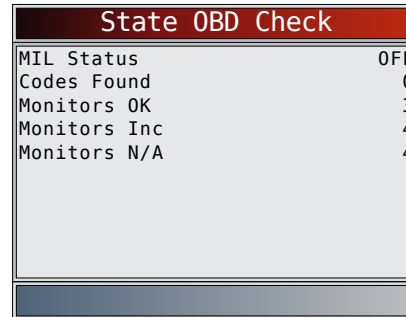

3. Return to **Special Tests Menu**.
 - Press **BACK**.

5.6 View Data

The **View Data** function allows real time viewing of the vehicle's computer module's parameter identification (PID) data. As the computer monitors the vehicle, information is simultaneously transmitted to scan tool.

View Data allows the following items to be viewed on the scan tool:

- Sensor data
- Operation of switches
- Operation of solenoids
- Operation of relays

View Data can be shown as:

- Entire Data List
- Custom Data List

Apart from **Read Codes**, **View Data** is the most useful diagnostic function for isolating the cause of a vehicle operation problem.

From **Datastream Menu**:

1. Select **View Data**.
 - Use the ▲ **UP** and ▼ **DOWN** keys until **View Data** is highlighted.
 - Press **ENTER**.

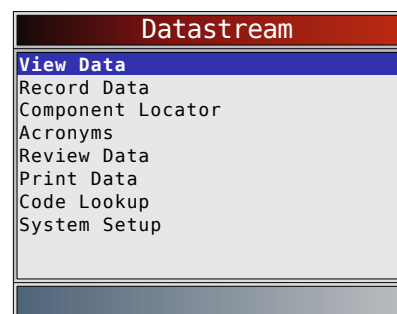

2. Observe while the scan tool validates PID MAP.
 - PID MAP validation is the tool asking the vehicle which PIDs are supported. Refer to "11 Appendix A—Global OBD II PID Definitions" on page 63 for a complete list of PIDs supported by the tool.
 - Multiple PIDs may be sent if vehicle is equipped with more than one computer module (for example a powertrain control module [PCM] and a transmission control module [TCM]). The scan tool identifies them by their identification

names (ID) assigned by manufacturer (i.e. \$10 or \$1A).

- If one or more control module stops responding, the scan tool displays a message.
 - If continuing, dashes will replace data in right-hand column.
 - If **NO** is selected, then the scan tool attempts to re-establish communication with that module.

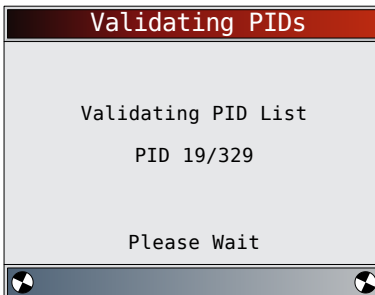
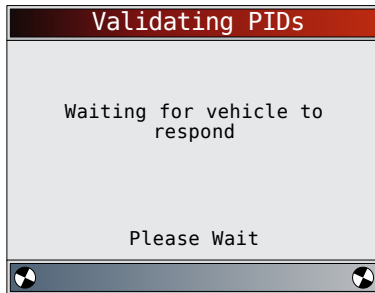

View Entire List

View Entire List shows all supported PID data for the vehicle being tested.

From **Select Data to View** menu:

1. Select **Entire Data List**.
 - Use the ▲ **UP** and ▼ **DOWN** keys until **Entire Data List** is highlighted.
 - Press **ENTER**.

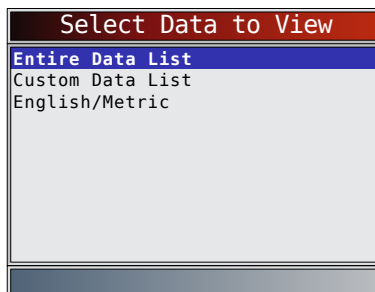

2. View PIDs on scan tool.
 - Use the ▲ **UP** and ▼ **DOWN** keys.
 - Refer to “11 Appendix A–Global OBD II PID Definitions” on page 63.

ABS LOAD(%)	0.0
ABSLT TPS(\$01)	6.3
ABSLT TPS(\$07)	6.3
ACC POS D(%)	0.0
BARO PRS("HG)	29.2
CALC LOAD(%)	0.0
CALC LOAD(%)	0.0
CAT TEMP11(°F)	73
CLR DIST(mi)	499
CLR DIST(mi)	513

Absolute Load Value

If Long PID Names is turned ON, the expanded text for the PID will scroll on the bottom line of display. Refer to “Long PID Names” on page 16.

If the  icon displays while a PID is selected, press **ENTER** to select PIDs to graph. A maximum of 2 PIDs can be graphed.

Select PIDs to Graph	
<input checked="" type="checkbox"/>	ABSLT TPS(%)
<input type="checkbox"/>	CALC LOAD(%)
<input type="checkbox"/>	COOLANT(°F)
<input type="checkbox"/>	ENG SPEED(RPM)
<input type="checkbox"/>	EQ RATIO11
<input type="checkbox"/>	IAT(°F)
<input type="checkbox"/>	IGN ADV(°)
<input type="checkbox"/>	LT FTRM1(%)

Throttle Position

- Use the ► **RIGHT** arrow key to select/deselect PIDs. The highlighted PID from when **ENTER** was pressed is already selected
 - Use the ◀ **LEFT** arrow key to deselect all PIDs.
 - Press **ENTER** to view graph of selected PIDs.
 - When graphing two PIDs, use the ▲ **UP** and ▼ **DOWN** keys to highlight the desired PID, which will also display the appropriate scale.
 - Press the **ENTER** key to pause the graph. Press the **ENTER** key again to continue graphing.
 - If the  icon displays while a PID is selected press **ENTER** to view graph.
3. Return to PID screen.
 - Press **BACK**.
 4. Return to **Select Data to View** menu.
 - Press **BACK**.
 5. Return to **Datastream Menu**.
 - Press **BACK**.

Custom List Select

The Custom Data List allows certain PIDs from the View Entire Data List, such as those PIDs that apply to a specific driveability symptom or system, to be selected.

From **Select Data to View** menu:

1. Select **Custom List Select**.
 - Use the ▲ **UP** and ▼ **DOWN** keys until **Custom Data List** is highlighted.
 - Press **ENTER**.

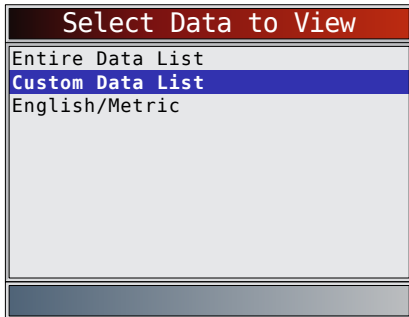

2. Select View Instructions or Not.
 - Use the ◀ **LEFT** and ▶ **RIGHT** keys.
 - Press **ENTER**.



3. Select PIDs to View.
 - Use the ▲ **UP** and ▼ **DOWN** keys to move up and down list.
 - The ▶ **RIGHT** arrow selects or deselects data parameter. All selected data values are marked with a ✓ symbol.
 - The ◀ **LEFT** arrow deselects all marked data parameters.
 - The **ENTER** key starts recording data or displaying selected data parameters.
 - If Long PID Names is turn ON, the expanded text for the PID will scroll on the bottom line of display. Refer to “Long PID Names” on page 16.
 - Selected PIDs are kept until you exit View Data and return to the **Datastream Menu**.

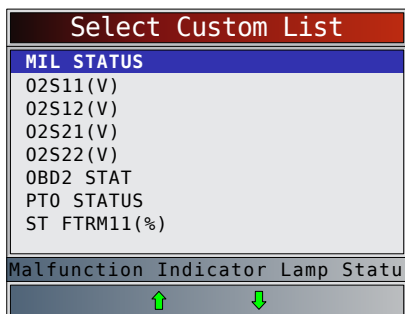

4. View PIDs on scan tool.
 - Use the ▲ **UP** and ▼ **DOWN** arrow key.
 - Refer to “11 Appendix A—Global OBD II PID Definitions” on page 63.

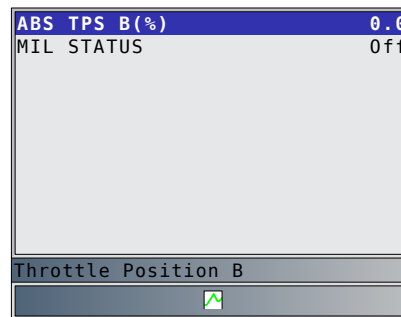

- If the  icon displays while a PID is selected, press **ENTER** to view graph. Press **BACK** to return to PID Screen. Refer to “View Entire List” on page 33 for instructions on how to select PIDs to graph and how to view graph.
5. Return to Select Data to View Menu.
 - Press **BACK**.
 6. Return to **Datastream Menu**.
 - Press **BACK**.

5.7 Record Data

The **Record Data** function records PIDs while vehicle is parked or being driven. The **Record Data** function is mainly used for diagnosing intermittent driveability problems that cannot be isolated by any other method. The recording time varies. A recording consists of frames of data before the trigger and several frames after the trigger.



CAUTION

Two people must be in vehicle when driving. One to drive and the other to operate the scan tool.

From **Datastream Menu**:

1. Select **Record Data**.
 - Use the ▲ **UP** and ▼ **DOWN** keys until **Record Data** is highlighted.
 - Press **ENTER**.

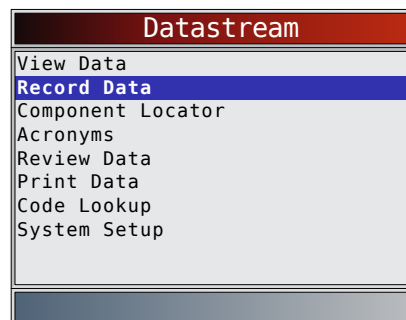

2. Follow all instructions on display.
 - The scan tool can maintain 5 recordings per vehicle. If there are already 5 recordings stored, the scan tool will ask which recording to overwrite.
 - Scan tool validates list of global PIDs from vehicle.

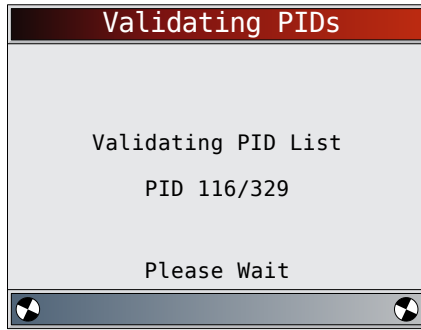

- Refer to "5.6 View Data" on page 32 to setup **Custom List** or **View Entire List** and **Pre-Trigger Setup** to set the number of frames to keep prior to triggering the recording.

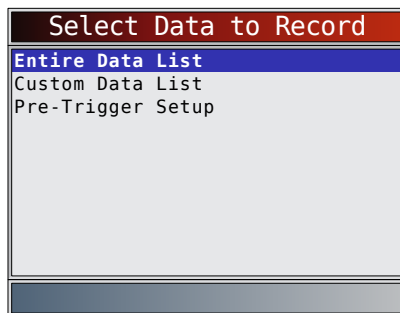

- Press **ENTER** to begin recording.
 - Data continues to be saved until either:
 - Record memory is full.
 - Operator presses **ENTER**.
 - Scan tool recording times vary. A recording consists of frames of data before trigger and several frames after trigger.

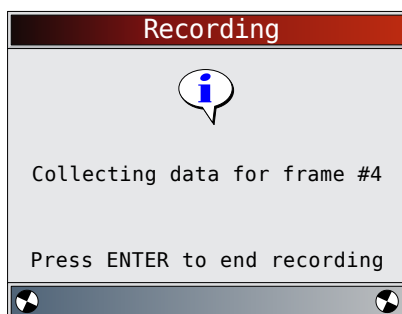

- After recording, scan tool displays a prompt to Playback Data.

- Select **NO** to return to **Datastream Menu**.
- Select **YES** to display recorded data.
- Refer to "Recording" on page 20 for instructions on how to play back data.



5.8 View Freeze Data

When an emission-related fault occurs, certain vehicle conditions are recorded by the on-board computer. This information is referred to as freeze frame data. **View Freeze Data** is a snapshot of the operating conditions at the time of an emission-related fault. **View Freeze Data** can be overwritten by faults with a higher priority. If codes were erased, **View Freeze Data** may not be stored in vehicle memory depending on vehicle.

From **Diagnostic Codes Menu**:

- Select **View Freeze Data**.
 - Use the **▲ UP** and **▼ DOWN** keys until **View Freeze Data** is highlighted.
 - Press **ENTER**.

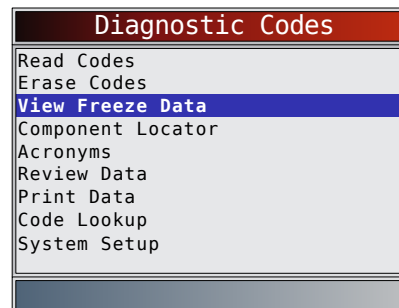

- Select frame if more than one frame is present.
 - Use the **▲ UP** and **▼ DOWN** keys until the desired frame is highlighted.
 - Press **ENTER**.

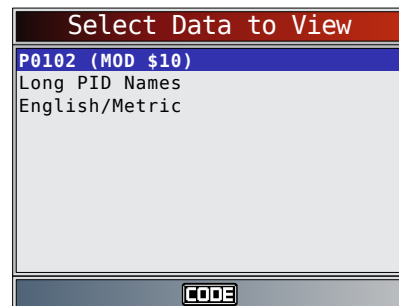









- View PIDs on scan tool.
 - Use the **▲ UP** and **▼ DOWN** keys.

- Refer to “11 Appendix A—Global OBD II PID Definitions” on page 63.

TROUB CODE	P2122
FUEL SYS 1	N/A
FUEL SYS 2	N/A
CALC LOAD(%)	0.0
COOLANT (°F)	-40
ST FTRM1(%)	0.0
LT FTRM1(%)	0.0
MAP ("HG)	28.1
ENG SPEED(RPM)	0
VEH SPEED(MPH)	0

Definition that caused Freeze Fra

- If Long PID Names is turned on, the expanded text for the PID will scroll on the bottom line of the display. Refer to “Long PID Names” on page 16.
 -  icon indicates that the  key is active. Press the  key to display repair information. Refer to “4.11 CodeConnect® Feature” on page 24.
 -  indicates that the  key is active. Press  to display the DTC definition of the DTC that created the Freeze Frame.
- Select another frame to view (if available).
 - Press .
 - Return to **Diagnostic Codes Menu**.
 - Press .

5.9 Drive Cycle Monitor

The **Drive Cycle Monitor** function is very similar to **I/M Monitors** though the **Drive Cycle Monitor** is used to view real-time operations of the emissions system on OBD II vehicles. **Drive Cycle Monitor** continuously updates as the vehicle reports operations of the emission system.



CAUTION

Two people must be in vehicle when driving. One to drive and the other to operate the scan tool.

- Refer to the vehicle service manual for the drive cycle operation.

Drive Cycle Monitor can be used if you want to drive the vehicle until all of the monitors are OK.



During normal driving conditions, the vehicle computer scans the emission system. After a specific amount of drive time (each monitor has specific driving conditions and time requirements), the computer monitors will decide if the vehicle emissions system is working correctly or not as well as detecting out a range of values. When the monitor status is:

- “ok” - vehicle has been driven enough for function.
- “inc” (incomplete) - vehicle was not driven enough to complete all of the monitors.
- “n/a” (not applicable) - vehicle does not support that monitor.

Reset monitors by:

- Erasing codes.
- Vehicle computer module losing power (on some vehicles).

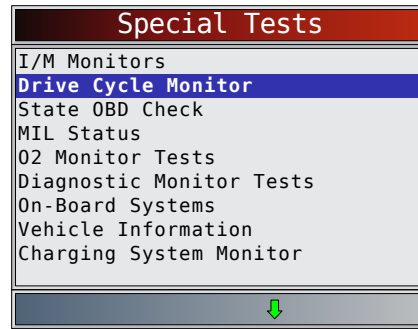

From **Special Tests Menu**:

- Select **Drive Cycle Monitor**.
 - Use the  and  keys until **Drive Cycle Monitor** is highlighted.
 - Press .

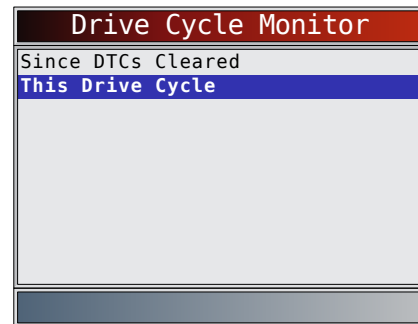

- Two types of drive cycle monitors are:
 - **Since DTCs Cleared** shows status of the monitors since the Diagnostic Trouble Codes were last erased.
 - **This Drive Cycle** shows status of monitors since start of current drive cycle. Refer to the vehicle service manual for more detailed information on emission-related monitors and their status.
 - Some vehicles do not support **Drive Cycle Monitor**. If vehicle supports both types of drive cycle monitors the **Drive Cycle Monitor** menu will display.



- View summary of monitor status.
 - Use the  and  keys (if required).
- Depending on the drive cycle monitors, either the **This Drive Cycle** or the **Since DTCs Cleared** screen will display.

This Drive Cycle	
Catalyst Mon	inc
Oxygen Sens Mon	inc
Oxygen Sens Htr	inc
EGR/VVT Sys Mon	inc

OR

Since DTCs Cleared	
Misfire Monitor	ok
Fuel System Mon	ok
Comp Component	ok
Catalyst Mon	ok
Htd Catalyst	n/a
Evap System Mon	inc
Sec Air System	n/a
A/C Refrig Mon	n/a
Oxygen Sens Mon	ok

- The scan tool display is continuously updated. Monitors that are “ok” will disappear and only the “inc” monitors will remain displayed. Monitors designated “n/a” are not displayed.
- When all Monitors are “OK”, a screen stating “All supported monitors are OK” will display.



OR

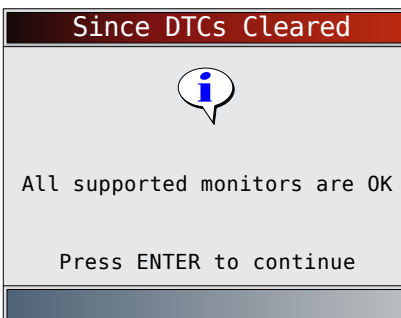

- Return to **Special Tests Menu**.
 - Press **BACK**.

5.10 O2 Monitor Tests

OBID II regulations require applicable vehicles monitor and test oxygen (O2) sensors to determine problems related to fuel and emissions. The O2 Monitor Tests allows retrieval of completed O2 sensors monitor test results.

- The **O2 Monitor Tests** is not an on-demand test. O2 sensors are not tested when selected via the menu. O2 sensors are tested when engine operating conditions are within specified limits.
- If the vehicle communicates using a controller area network (CAN), **O2 Monitor Tests** are not supported by vehicle. A message is displayed. Refer to “5.11 Diagnostic Monitor Tests” on page 38 for O2 monitor data.
- O2 sensors are located before (upstream) and after (downstream) catalyst(s). Sensors are named (xy) for their position to both cylinder banks and catalysts.
 - The O2 sensor for cylinder bank 1 has prefix 1y while O2 sensor for cylinder bank 2 has prefix 2y.
 - The O2 sensor upstream of catalyst (closest to engine) has suffix x1 while O2 sensor downstream of catalyst has suffix x2. If vehicle contains more catalysts, O2 sensor downstream of second catalyst has suffix x3 and O2 sensor downstream of next catalyst has suffix x4.
 - For example, O2S21 is upstream O2 sensor for cylinder bank 2.

The following O2 Sensor Tests are available:

- Rich-to-lean sensor threshold voltage
- Lean-to-rich sensor threshold voltage
- Low sensor voltage for switch time
- High sensor voltage for switch time
- Rich-to-lean sensor switch time
- Lean-to-rich sensor switch time
- Minimum sensor voltage test cycle
- Maximum sensor voltage test cycle
- Time between sensor transitions
- Sensor period
- Manufacturer specific tests

From **Special Tests Menu**:

- Select **O2 Monitor Tests**.
 - Use the **▲ UP** and **▼ DOWN** keys until **O2 Monitor Tests** is highlighted.
 - Press **ENTER**.

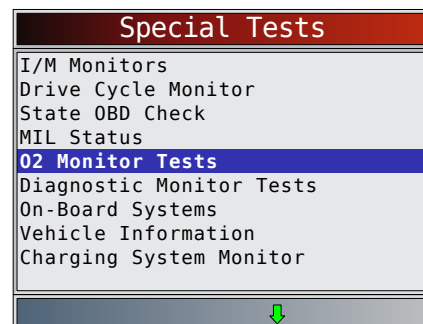

2. Select O2 sensor.
 - Use the ▲ **UP** and ▼ **DOWN** keys until the desired O2 monitor is highlighted.
 - Press **ENTER**.

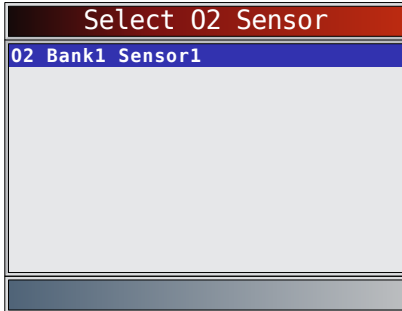

- The O2 sensors located upstream (before catalyst) may perform differently than ones located downstream (after catalyst).
- Test IDs are shown for unknown O2 sensor tests.

3. View results of selection.
 - Use the ▲ **UP** and ▼ **DOWN** keys.

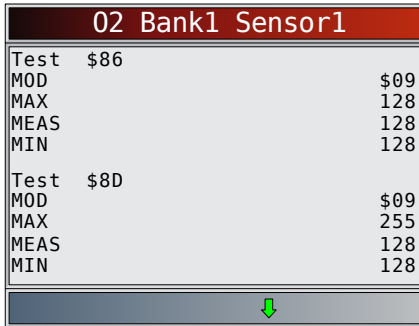

4. Return to **O2 Sensor Tests** menu.
 - Press **BACK**.
5. Return to **Special Tests Menu**.
 - Press **BACK**.

5.11 Diagnostic Monitor Tests

The **Diagnostic Monitor Test** function is useful after servicing or after erasing a vehicle's memory. Test results do not necessarily indicate a faulty component or system.

- Non-CAN vehicles **Diagnostic Monitor Test** receives test results for emission-related powertrain components and systems that are not continuously monitored.
- CAN vehicles **Diagnostic Monitor Test** receives test results for emission-related powertrain components and systems that are and are not continuously monitored.
- Vehicle manufacturer is responsible for assigning test and component IDs.

From **Special Tests Menu**:

1. Select **Diagnostic Monitor Tests**.
 - Use the ▲ **UP** and ▼ **DOWN** keys until **Diagnostic Monitor Tests** is highlighted.
 - Press **ENTER**.

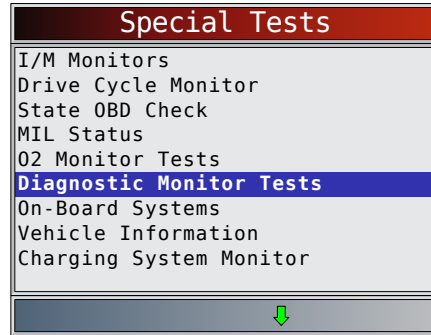

- Applicable diagnostic monitor tests are displayed.
2. Review test results displayed on scan tool.
 - Use the ▲ **UP** and ▼ **DOWN** keys until desired result is highlighted.
 - Press **ENTER**.

Non-CAN Vehicles

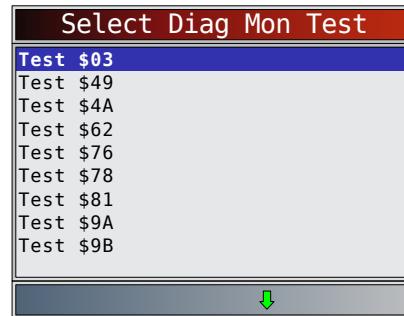

Refer to appropriate vehicle service manual for test IDs and definitions.

CAN Vehicles

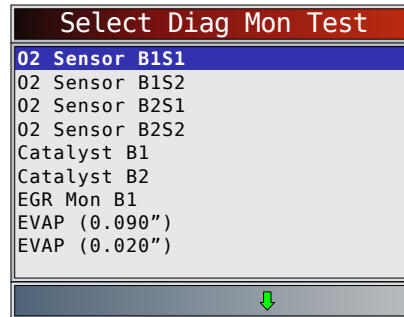

On Non-CAN vehicles the scan tool displays:

- Test data (test ID)
- Maximum value (MAX)
- Test measurements (MEAS)
- Minimum value (MIN)
- Status (STS)
- Measurements and Specification values are hexadecimal numbers (i.e., \$1A, \$FE, \$11.)
- Module (MOD)

Test \$03	
ID	01
MOD	\$09
MAX	----
MEAS	00
MIN	00
STS	OK

- On CAN vehicles scan tool displays:
 - Test performed. The test performed can be \$## if test is not defined. Refer to vehicle service manual for details.
 - Measured values and units of measured (such as volts, amps, and seconds).
 - Status of monitor test data.
 - Module ID where the monitor test data came from.

O2 Sensor B1S1	
RICH-LN Thresh	
MOD	\$07
MAX	0.4497 (V)
MEAS	0.4497 (V)
MIN	0.4497 (V)
STS	OK

- Return to **Select Test** menu.
 - Press **BACK**.
- Return to **Special Tests Menu**.
 - Press **BACK**.

5.12 On-Board Systems

The **On-Board Systems** test allows the scan tool to control operation of vehicle components, tests or systems.

- Some manufacturers do not allow tools to control vehicle systems. A vehicle not supporting an on-board system is identified by a message that is displayed when selected.
- Refer to the vehicle service manual for on-board systems instructions.
- The manufacturer is responsible for determining the criteria to automatically stop test. Refer to appropriate vehicle service manual.

From **Special Tests Menu**:

- Select **On-Board Systems**.
 - Use the **▲ UP** and **▼ DOWN** keys until **On-Board Systems** is highlighted.
 - Press **ENTER**.

Special Tests
I/M Monitors
Drive Cycle Monitor
State OBD Check
MIL Status
O2 Monitor Tests
Diagnostic Monitor Tests
On-Board Systems
Vehicle Information
Charging System Monitor

- A list of on-board systems and components available for testing are shown on the display.
- Select test.
 - Use the **▲ UP** and **▼ DOWN** keys until desired test is highlighted.
 - Press **ENTER**.

On-Board Systems
EVAP System Test

On-Board Systems
 Command sent Press ENTER to continue

- Return to **On-Board Systems** menu.
 - Press **ENTER**.
- Return to **Special Tests Menu**.
 - Press **BACK**.

5.13 Vehicle Information

The **Vehicle Information** function allows the scan tool to request the vehicle's VIN number, calibration ID(s) which identifies software version in vehicle control module(s), calibration verification numbers (CVN(s)) and in-use performance tracking.

- Vehicle Information** function applies to model year 2000 and newer OBD II compliant vehicles.
- The scan tool cannot verify if data is correct for scanned vehicles.
- CVNs are calculated values required by OBD II regulations.
- The CVN calculation may take several minutes.

- CVNs are reported to determine if emission-related calibrations have been changed. Multiple CVNs may be reported for a control module.
- In-use performance tracking tracks performance of key I/M Monitors.

From **Special Tests Menu**:

1. Select **Vehicle Information**.
 - Use the ▲ **UP** and ▼ **DOWN** keys until **Vehicle Information** is highlighted.
 - Press **ENTER**.

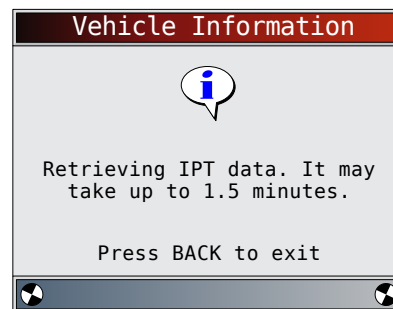
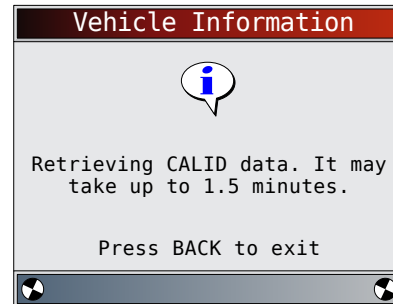
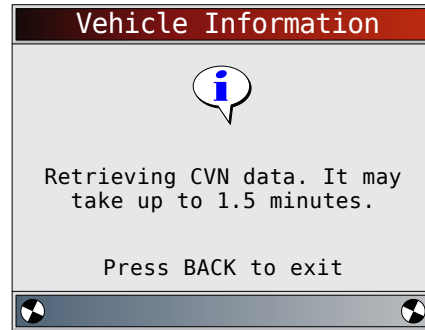
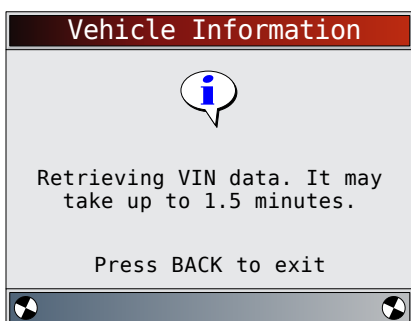
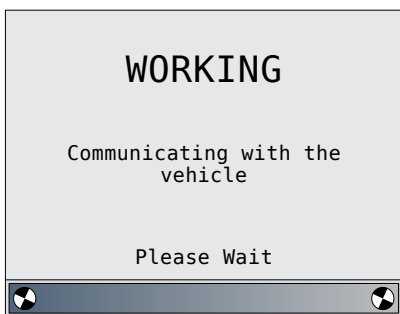
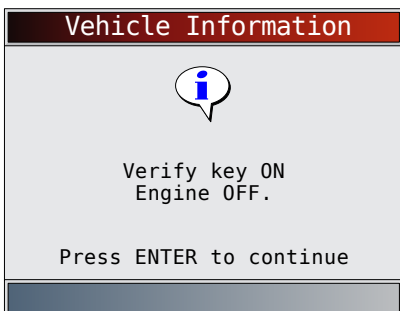
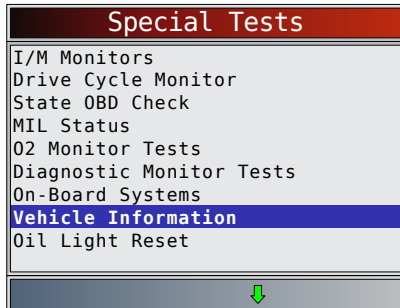

2. Select information to view from the menu.
 - Use the ▲ **UP** and ▼ **DOWN** keys until desired selection is highlighted.
 - Press **ENTER**.

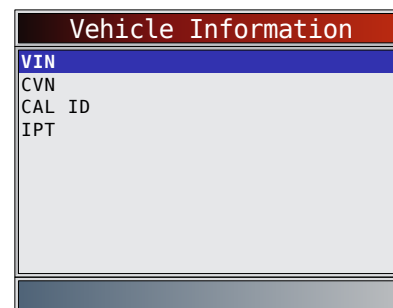

- If the selected menu item has data for more than one module, a menu listing all modules returning data for that menu item is shown.
3. View information supported by vehicle.
 - Use the ▲ **UP** and ▼ **DOWN** keys (if required).

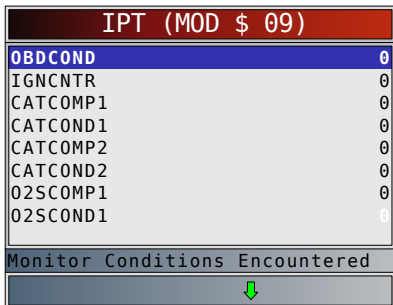
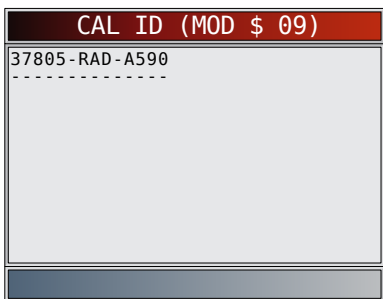
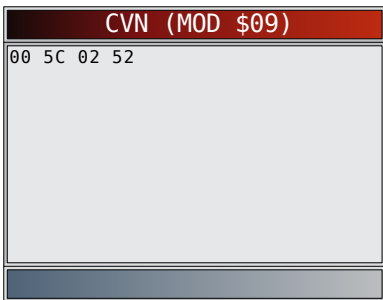
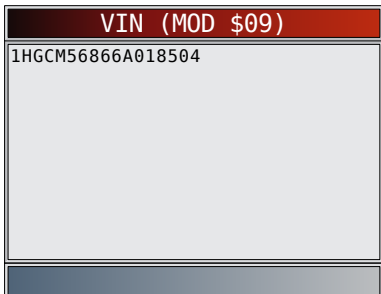

- In the above examples, Module \$09 returned data. Scroll down to view information. CVNs are shown as hexadecimal numbers.
- Abbreviations and names for in-use performance tracking data supported by the Tool are shown below. Not all data is supported by all vehicles.

Abbreviated Name	Expanded Name
In-Use Perf Tracking	In-Use Performance Tracking
OBDCOND	OBD Monitoring Conditions Encountered Counts
IGNCNTR	Ignition Counter
CATCOMPX	Catalyst Monitor Completion Counts Bank x
CATCONDX	Catalyst Monitor Conditions Encountered Counts Bank x

O2SCOMPX	O2 Sensor Monitor Completion Counts Bank x
O2SCONDx	O2 Sensor Conditions Encountered Counts Bank x
EGRCOMP	EGR Monitor Completion Condition Counts
EGRCOND	EGR Monitor Conditions Encountered Counts
AIRCOMP	AIR Monitor Completion Condition Counts (Secondary Air)
AIRCOND	AIR Monitor Conditions Encountered Counts (Secondary Air)
EVAPCOMP	EVAP Monitor Completion Condition Counts
EVAPCOND	EVAP Monitor Conditions Encountered Counts

- If message INVALID displays on screen, the data returned from the vehicle is incorrect, or is not formatted in accordance with OBD II specifications.
- Return to **Vehicle Information** menu.
 - Press **BACK**.
 - Return to **Special Tests Menu**.
 - Press **BACK**.

5.14 Oil Light Reset

The Oil Light Reset function allows the scan tool to reset oil life to 100% and turn off the change oil light. This function will only appear on the Special Tests menu when supported by the currently selected vehicle.

From **Special Tests Menu**:

- Select **Oil Light Reset**.
 - Use the **▲ UP** and **▼ DOWN** keys until **Oil Light Reset** is highlighted.
 - Press **ENTER**.

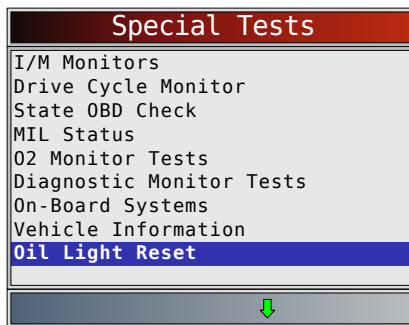

- Follow the instructions displayed. They will vary depending on the vehicle.
 - Press **ENTER**.



3. Reset oil light.
 - Press **ENTER**.



4. After the command is sent, the oil light should be off.
 - Press **ENTER** to return to the **Special Tests Menu**.



5.15 Battery Reset

The Battery Reset function allows the scan tool to tell the vehicle that the battery has been replaced. This function will only appear on the Special Tests menu when supported by the currently selected vehicle. Resetting the battery system when a new battery is installed allows the vehicle to customize charging to the age and condition of the battery.

Battery Information

The vehicle may contain either a lead-acid battery or an AGM (absorbed glass mat) battery. Leadacid batteries contain liquid sulphuric acid and can spill when overturned. AGM batteries also contain sulphuric acid, but the acid is contained in glass mats between the terminal plates.

If the original battery is replaced with a different type of battery (eg. a lead-acid battery is replaced with an AGM

battery) or a battery with a different capacity (mAh), the vehicle may require reprogramming to the new battery type in addition to performing the battery reset. Reprogramming is not a function of the tool. Consult the vehicle manual for additional vehicle-specific information.

From the **Special Tests Menu**:

1. Select **Battery Reset**.
 - Use the **▲ UP** and **▼ DOWN** keys until **Battery Reset** is highlighted.
 - Press **ENTER**.

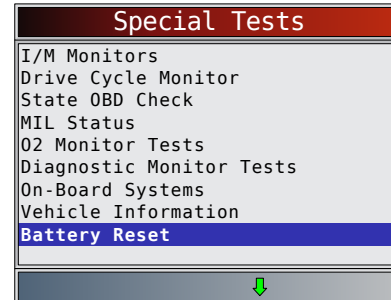

2. Follow the instructions displayed. They will vary depending on the vehicle.
 - Press **ENTER**.

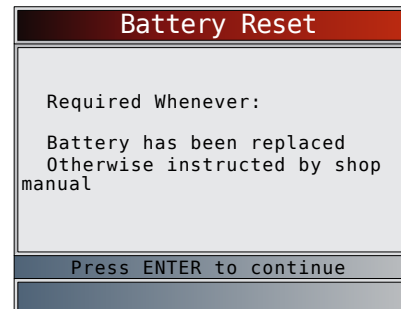

3. Perform **Battery Reset**.
 - The messages displayed during battery reset will vary depending on the vehicle.



4. Battery Reset Complete.
 - Press **ENTER** to return to the **Special Tests Menu**.

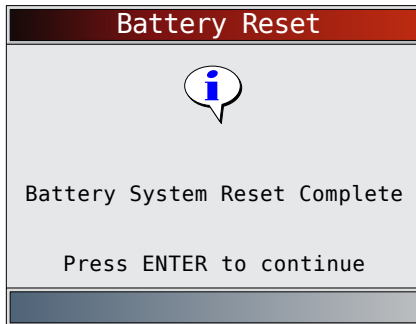

5.16 Charging System Monitor

The **Charging System Monitor** function allows the scan tool to provide voltage measurements at the DLC to give an indication of battery, starter, and alternator performance.

From the **Special Tests Menu**:

1. Select **Charging System Monitor**.
 - Use the ▲ **UP** and ▼ **DOWN** keys until **Charging System Monitor** is highlighted.
 - Press **ENTER**.

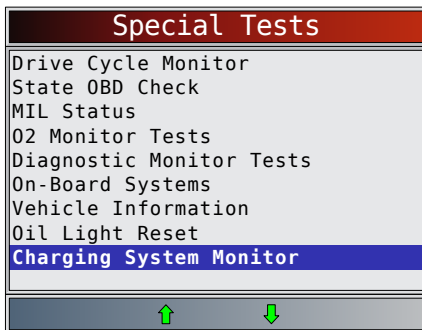

2. Turn the ignition key on but do not start the engine.
 - Press **ENTER**.

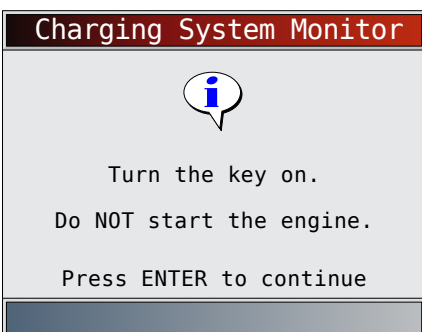

3. The DLC voltage is measured at key on engine off.
 - The screen below shows a KOEO voltage of 12.2V.
 - Start the engine or press **BACK** to return to the Diagnostic Menu. The scan tool will monitor the DLC voltage and progress to step 4 if starter cranking is detected.

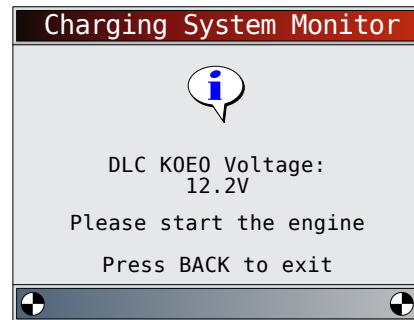

4. When the cranking condition is detected, the scan tool will begin collecting DLC voltage readings.
 - If the engine starts, press **ENTER**.

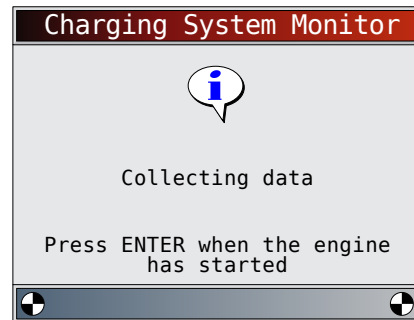

5. If an engine started condition is detected, the scan tool will collect key on engine running DLC voltages.

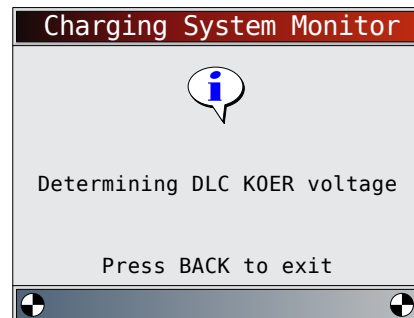

6. The test results are then displayed.

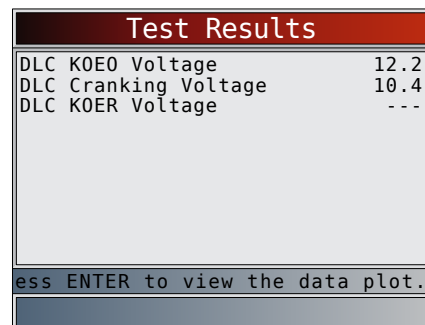

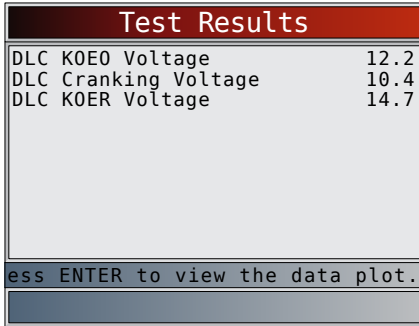

On the first screen, the scan tool didn't detect that the engine had started, so there isn't a KOER voltage reading.

The second screen did detect that the engine had started so there is a KOER reading.

The screen on the left shows that the KOEO voltage before an engine start was attempted was 12.2V. Once the starter began cranking the engine, a cranking voltage of 10.4V was measured. After the engine started, a KOER voltage reading of 14.7V was measured.

- If the KOEO voltage is very low, this could be an indication of a bad battery, or one that needs to be charged.
- If the cranking voltage is a lot lower than the KOEO voltage, than this is an indication of a worn starter.
- If the KOER voltage is not higher than the KOEO voltage, than this indicates a bad or weak alternator.

After reviewing the test results, Press **ENTER** to view the data plot.

- View the data plot.
 - The triangle below the graph indicates the position of the frame in the graph.
 - Use the **LEFT** and **RIGHT** arrow keys to scroll back and forth through graph.

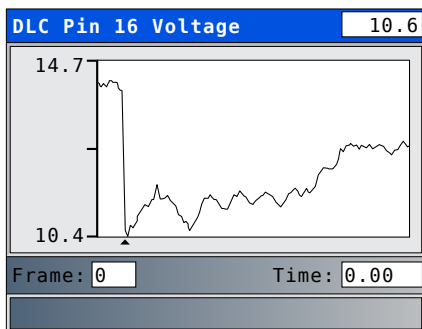

- Press **ENTER** to return to the Special Tests Menu.

5.17 Modules Present

The scan tool identifies the module IDs and communication type for all Global OBD II modules in the vehicle.

From the **Special Tests Menu**:

- Select **Modules Present**.
 - Use the **UP** and **DOWN** keys until **Modules Present** is highlighted.
 - Press **ENTER**.

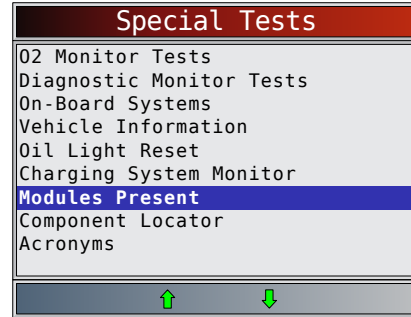

The types of protocols (communication types) supported by the scan tool are:

- ISO 9141-2 protocol is shown as ISO.

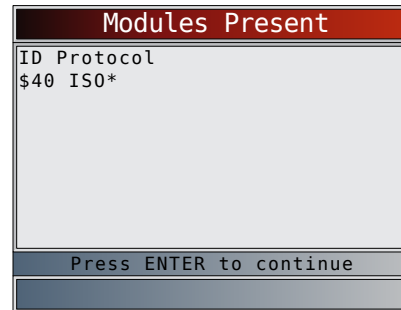

- SAE J1850 protocol is shown as VPWM or PWM.

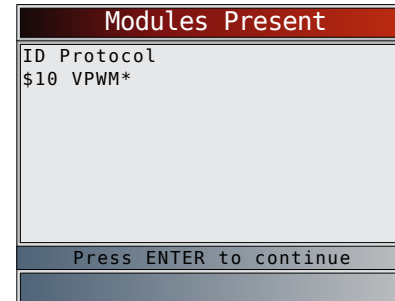

OR

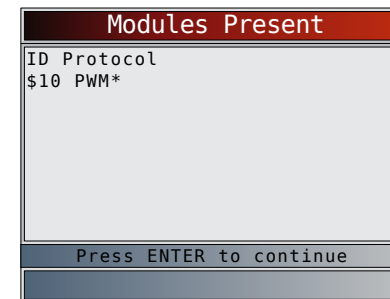

- ISO 15765-4 protocol is shown as CAN.

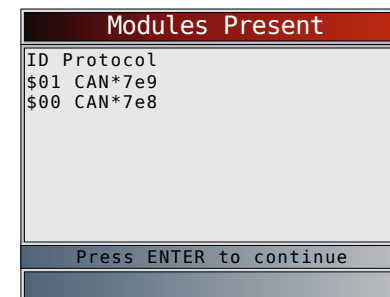

Since CAN vehicles use module IDs larger than 2 digits, the scan tool assigns a 2 digit module ID to be used in place of the actual CAN module ID. The module ID assigned for the CAN module ID is used in all functions of the scan tool.

- ISO 14230-4 protocol is shown as K2K (Keyword 2000).

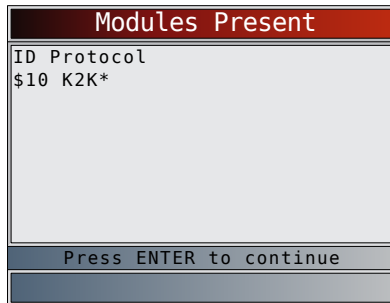

In the above examples, the * indicates the protocol used to communicate to the vehicle's control module.

6 GM OBD I Diagnostics

6.1 Diagnostic Menu



IMPORTANT

Review Data, Print Data, Code Lookup, Acronyms and System Setup are covered in Section 5 of this manual. These items are not covered in this section.

The **GM Function List** is broken down into the following selections:

- Datastream
 - View Data
 - Record Data
 - Acronyms
 - Review Data
 - Print Data
 - Code Lookup
 - System Setup
- Diagnostic Codes
 - Read Codes
 - Erase Codes
 - Acronyms
 - Review Data
 - Print Data
 - Code Lookup
 - System Setup
- Special Tests
 - Field Service
 - Acronyms
 - Review Data
 - Print Data
 - Code Lookup
 - System Setup
- Acronyms
- Review Data

- Print Data
- Code Lookup
- System Setup

Some 1994 and 1995 vehicles use the 16-pin OBD II connector, but are not OBD II compliant. They still use the OBD I application software.

If the scan tool displays an Error Message, make sure the cables and adapters are securely attached and the ignition key is on. Cycle the ignition key to OFF for 10 seconds, then ON. Attempt the test selected again. If the problem remains, refer to “10.1 Error Messages” on page 61.

6.2 View Data

The **View Data** function allows the user to view the vehicle Parameter Identification (PID) Data in real time. As the powertrain control module (PCM) monitors PIDs, they are simultaneously transmitted to the scan tool. The PIDs are continuously updated at the PCMs rate. In addition to reading codes, **View Data** is the most useful diagnostic function for isolating the cause of a vehicle operation problem. Viewing data is also used for observing sensor data and the ON/OFF state of switches, solenoids, and relays.

View Data can be performed with key on engine off (KOEO) or key on engine running (KOER).



CAUTION

Two people must be in vehicle when driving. One to drive and the other to operate the scan tool.

From **Datastream Menu**:

1. Select **View Data**.
 - Use the ▲ **UP** and ▼ **DOWN** keys until **View Data** is highlighted.
 - Press **ENTER**.

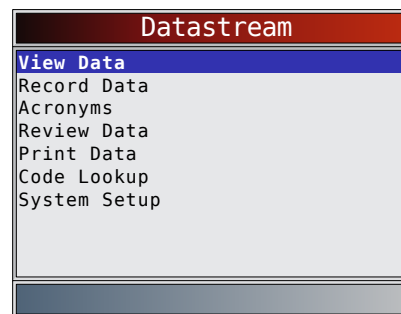

Multiple Group Vehicles

- Some vehicles display a Select PID Group screen for viewing data. In these cases, only one group of data can be viewed at a time.
 - If a Select PID Group screen does not appear, skip the Multiple Group section and continue these instructions with Step 3.
2. Select **Engine Group**.
 - Use the ▲ **UP** and ▼ **DOWN** keys until **Engine Group** is highlighted.

- Press **ENTER**.

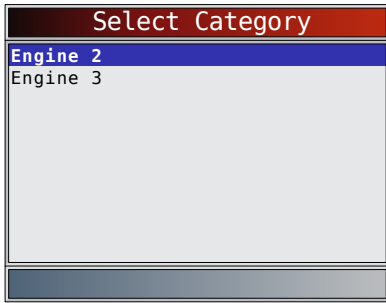

3. Select the type of data to review.
 - Use the **▲ UP** and **▼ DOWN** keys until data is highlighted. Refer to "5.6 View Data" on page 32 for Entire or Custom Lists.
 - Press **ENTER**.

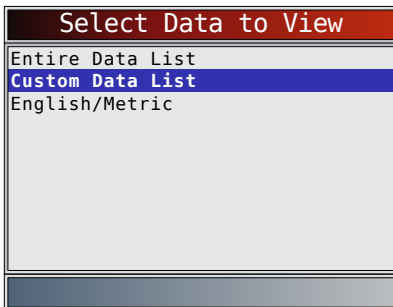

4. View PIDs on scan tool.
 - Use the **▲ UP** and **▼ DOWN** keys. Refer to "5.6 View Data" on page 32 for additional information.

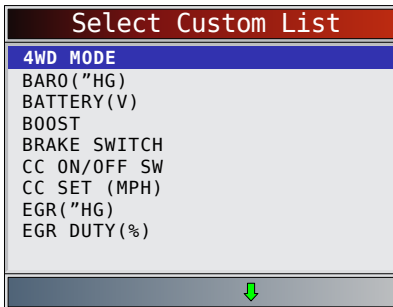

5. Return to **Select Data View Menu**.
 - Press **BACK**.
6. Return to **Datastream Menu**.
 - Press **BACK**.

6.3 Record Data

Refer to "5.7 Record Data" on page 34. GM groups the PIDs into three or fewer PID Groups. The PID Groups are referred to as Engine 1, Engine 2 and Engine 3. Some GM OBD I vehicles have only one PID group. For these vehicles, the selection menu does not appear.

6.4 Read Codes

The **Read Codes** function is used to retrieve all stored powertrain DTCs from the control module(s). This can be performed with KOEO or KOER. Two types of codes

were used by GM in the Historic System: current codes and history codes. Prior to 1986, all codes were referred to as current codes. From 1986 through 1995, both codes were used because the PCM was able to differentiate between them.

The scan tool automatically displays the type of codes that pertain to the vehicle under test. The DTC types are defined as follows:

- History Codes - intermittent codes are stored in the vehicle's memory when the trouble originally occurred. History codes remain present even if the trouble has been corrected. If no trouble code resurfaces after 50 engine warm-up cycles, the DTC is erased.
- Current Codes - codes transmitted through the PCM's data stream. When a trouble condition is active, it cannot be erased. The problem must be repaired to remove the DTC.

On some vehicles, all codes are current codes because the PCM cannot distinguish current codes from history codes. The only way to determine this is to erase the code and then drive the vehicle to see if the code returns. Perform the following:

1. Set parking brake.
2. KOEO or KOER.
3. Put transmission in park (P) or neutral (N).

From the **Diagnostic Codes Menu**:

1. Select **Read Codes**.
 - Use the **▲ UP** and **▼ DOWN** keys until **Read Codes** is highlighted.
 - Press **ENTER**.

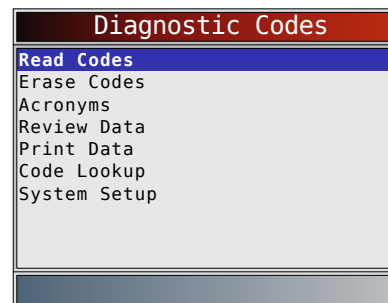

The scan tool retrieves DTCs. If no DTCs are present, a message stating "No codes found" is displayed.

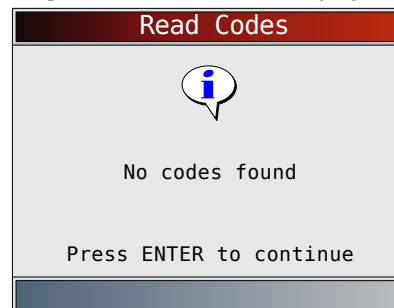

2. View and write down the DTCs.
 - Use the **▲ UP** and **▼ DOWN** keys until the desired choice is highlighted.

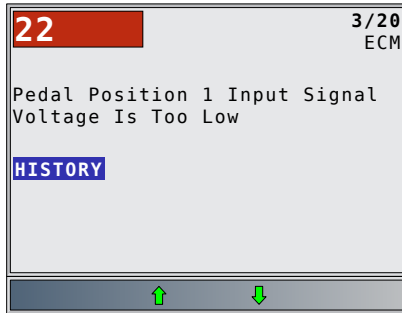

- Return to **Diagnostic Codes Menu**.
 - Press **BACK**.

6.5 Erase Codes

The **Erase Codes** function deletes DTCs and resets I/M Monitor data from vehicle's control module(s). Perform this function with KOEO or KOER. Perform this function only after the systems have been checked completely and DTCs have been documented.

After servicing the vehicle, erase stored DTCs and verify no codes have returned. If a DTC returns, problem has not been fixed or other faults are present.

Some codes can only be removed by repairing the faults that caused them. Therefore, these codes remain in the vehicle's memory until the condition is repaired.

Not all trouble codes can be automatically erased using the scan tool. Some vehicles require a manual erasing procedure (refer to "6.6 Manual Erase Methods" on page 47). When possible, the tool performs the appropriate **Erase Codes** procedure for your vehicle.

From **Diagnostic Codes Menu**:

- Select **Erase Codes**.
 - Use the **▲ UP** and **▼ DOWN** keys until **Erase Codes** is highlighted.
 - Press **ENTER**.

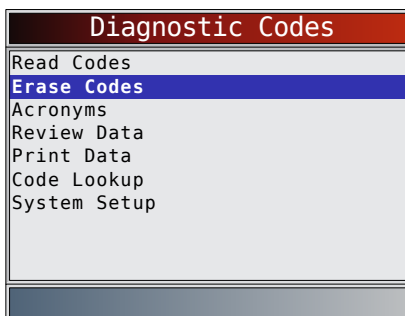

- If diagnostic results and codes are not to be erased select **NO** and press **ENTER**.

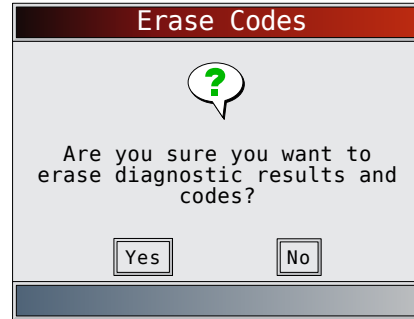

- Selecting **NO** displays a "Command cancelled" message.

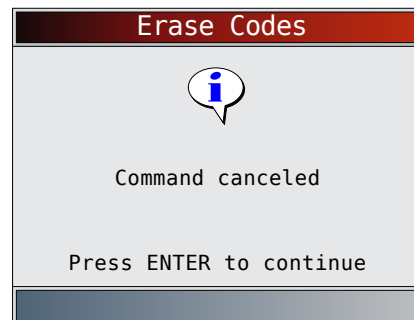

- Select **YES** to erase diagnostic results and codes.
 - Use the **◀ LEFT** arrow key.
 - Press **ENTER**.

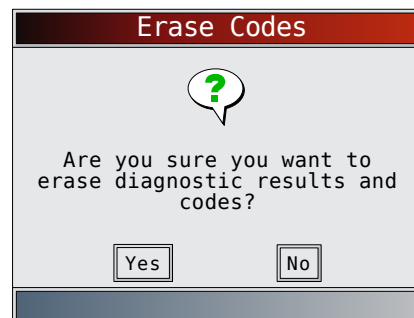

- Observe "Command sent" message is displayed.
 - Press **ENTER**.

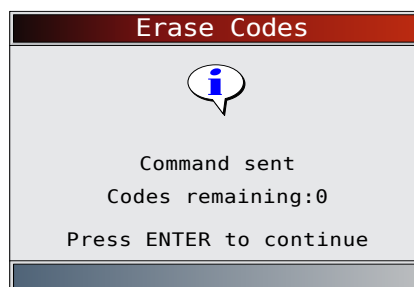

- Return to **Diagnostic Codes Menu**.
 - Press **BACK**.

6.6 Manual Erase Methods

Alternate Method 1:

- Turn ignition key off.

2. Locate fuse box and remove ECM fuse.
3. Wait 20 seconds.
4. Replace the fuse.

Alternate Method 2:

1. Turn ignition key off.
2. Remove power from the scan tool.
3. Disconnect scan tool from the vehicle.
4. Disconnect Negative (-) battery cable. Wait 30 seconds, then replace the cable.

The computer has a learning ability to compensate for minor variations in engine operation. Whenever power is removed from the PCM, the computer must relearn various functions. Vehicle performance may be noticeably different until this is accomplished. This is a temporary situation and is normal. The learning process takes place during warm engine driving.

6.7 Field Service

Field Service is a special diagnostic mode to monitor fuel system operation and read DTCs. Some GM service manuals may refer to this mode as the Field Service mode check. This mode works on vehicles equipped with a 12-pin ALDL connector with a wire present in pin-B, Diagnostic or Test Enable. The scan tool enters this mode by grounding pin-B: shorting pin-B to pin-A (ground).

- Field Service Mode can be operated with KOEO or with KOER.
- Vehicles equipped with climate control computers do not use Field Service mode.
- Some 1994 and 1995 vehicles equipped with a 12-pin ALDL connector with pins A and B shorted will not cause the check engine light to flash codes.

From **Special Tests Menu:**

1. Select **Field Service**.
 - Use the ▲ **UP** and ▼ **DOWN** keys until **Field Service** is highlighted.
 - Press **ENTER**.

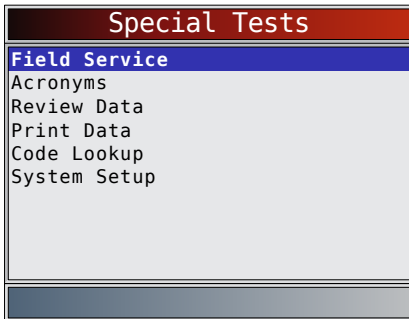

2. Check vehicle malfunction indicator lamp (MIL).
 - Turn ignition key on, but do not start engine. The check engine light should flash.
 - Select YES to continue.
 - If the light does not illuminate, either the vehicle does not support this test mode, the lamp is burned-out, or circuit problems exist.

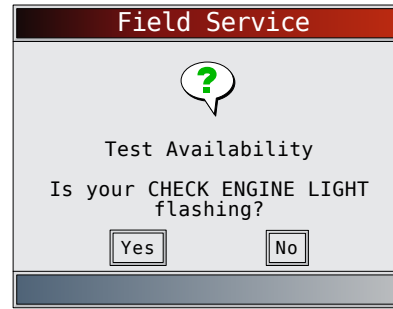

It is difficult to know exactly which GM vehicles use the Field Service mode. It is possible to have the Field Service mode function on the Special Tests Menu, and it not be applicable.

If CHECK ENGINE light operates, the Field Service screen is displayed.

3. Toggle Field Service ON/OFF.
 - Press **ENTER** to toggle the short to Pins A & B ON and OFF.
 - Continue with either the KOEO procedure or KOER procedure.
 - While in Field Service mode, no new DTCs are stored in the vehicle's memory.



KOEO Procedure

In the KOEO Procedure, Field Service can check relays, solenoids and the idle speed motor, and obtain DTCs using the check engine light.

1. Turn ignition key on but do not start engine.
2. On scan tool, place Field Service On.
3. The check engine light begins to flash codes. Each DTC is displayed three (3) times. The DTCs are displayed starting with the lowest numbered one. After all DTCs are displayed, the sequence keeps repeating until the ignition key or Field Service mode is turned OFF.
 - Count the number of times the check engine light flashes to obtain DTCs. The first digit is sent first. A short pause separates digits while a long pause separates each DTC. All codes contain 2 digits.
 - DTC 12 (no RPM reference pulse) should display first since the engine is not running. If not, problems exist in the PCM or check engine light circuitry.

Code 12 will look like:

FLASH-pause-FLASH-FLASH - long pause.

Code 23 will look like:

FLASH-FLASH-pause-FLASH-FLASH-FLASH – long pause.

4. When Field Service mode is on, most computer controlled relays and solenoids will be turned on, except for the fuel pump relay and fuel injectors. Toggle the Field Service mode ON and OFF.
 - Use a voltmeter to measure Relays and Solenoids input voltage to verify ON/OFF conditions. An ohmmeter could be used to check the continuity between the relay's switch terminals.
 - The idle air control (IAC) valve is fully seated to the zero position by the PCM.
 - The exhaust gas recirculation (EGR) solenoid is energized for 25 seconds.

KOER Procedure

With the engine running, the Field Service mode can be used to measure base timing, check open loop/closed loop operation, and determine if the engine is running rich or lean.

1. Engage parking brake and block drive wheels.
2. Verify engine is cold. If engine is hot or warm, allow it to cool.
3. On scan tool, place Field Service ON.
4. Start engine and place transmission in park (P) or neutral (N). The check engine light flashes once.
5. Warm the engine by idling for 2 minutes at 2000 RPM.
6. Observe check engine light.
 - If check engine light flashes 2.5 times a second, the on-board computer is operating in Open Loop.
 - When the engine warms up to normal operating temperature, the on-board computer is now operating in closed loop. The check engine light should flash once a second. The on-board computer is now operating in closed loop.
 - If check engine light:
 - flashes equally ON/OFF, then the fuel system is running normally.
 - is mostly on, then the fuel system is running rich.
 - is mostly off, then the fuel system is running lean.
7. On some engines, the spark advance timing is fixed during Field Service mode. This allows the technician to measure the engine base timing.
8. Return to **Special Tests Menu**.
 - Press .

7 Ford OBD I Diagnostics

7.1 Diagnostic Menu

This system applies to Ford vehicles manufactured prior to 1996. Due to different processor calibrations, the diagnostic options may vary for a particular vehicle.

Based on the vehicle information entered, the tool automatically recognizes the computer system installed.

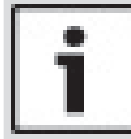
**IMPORTANT**

View Data, Record Data, Review Data, Print Data, Code Lookup, Acronyms and System Setup are covered in Section 5 of this manual. These items are not covered in this section.

The **Ford Function List** is broken down into the following selections:

- Datastream
 - View Data
 - Record Data
 - Acronyms
 - Review Data
 - Print Data
 - Code Lookup
 - System Setup
- Diagnostic Codes
 - Read KOEO Fast Codes
 - Read KOEO Slow Codes
 - Read KOER Fast Codes
 - Read KOER Slow Codes
 - Erase Codes
 - IVSC KOEO Codes
 - IVSC KOER Codes
 - Acronyms
 - Review Data
 - Print Data
 - Code Lookup
 - System Setup
- On Demand Tests
 - KOEO Wiggle Test
 - KOER Wiggle Test
 - Output Switch Test
 - Cylinder Balance Test
 - KOER Computed Timing
 - STAR Test Mode
 - Acronyms
 - Review Data
 - Print Data
 - Code Lookup
 - System Setup
- Acronyms
- Review Data
- Print Data
- Code Lookup
- System Setup

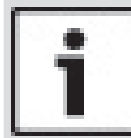
**IMPORTANT**

If the function is not supported by the vehicle, then the scan tool does not display it.

Most Ford vehicles prior to 1996 use the EEC-IV system. Vehicles with Mazda-sourced engines use the Mazda Electronic Control System (MECS).

If the scan tool displays an Error Message, make sure the adapter cable is securely attached and the ignition key is

on. Cycle the ignition key to off for 10 seconds, then on. This may be required because the Ford system allows only one Self-Test function to be performed for each key on. Attempt the test again and if the problem remains, refer to "10.1 Error Messages" on page 61. Datastream Menu functions are used to view and record engine data transmitted from the vehicle on EEC-IV vehicles beginning in 1990. These functions allow viewing of data parameters in real time to pinpoint problems when they occur. The scan tool also has the ability to record these data parameters as the vehicle is operated to locate intermittent problems.

Read KOEO Fast Codes / Read KOEO Slow Codes

The Read KOEO Codes function activates the key on engine off (KOEO) and Continuous Memory self-tests which retrieve KOEO and Continuous Memory diagnostic trouble codes (DTCs) from the PCM.

- KOEO DTCs are transmitted through the PCM data link when a trouble condition is active. KOEO codes remain until the trouble condition becomes inactive - usually when the fault is repaired.
- Continuous Memory DTCs are stored in the vehicle's memory at the time of occurrence during continuous self-test monitoring. They remain there until the problem does not reoccur within 40 warm-up cycles, Fast KOEO codes have been read, or the Erase Codes function has been run. Continuous memory codes follow the KOEO codes in the datastream.

The DTCs are transmitted in two formats; both transmit the same information:

- Slow Codes are regular service codes that allow the user to identify the faults with an analog voltmeter or the check engine light. Slow Codes are transmitted within 3 minutes. Retrieving Slow Codes does not erase Continuous Memory Codes.
- Fast Codes are transmitted within seconds and must be read with a diagnostic tool. Retrieving Fast Codes erases Continuous Memory Codes. Fast Codes do not apply to MECS vehicles.

From **Diagnostic Codes Menu:**

1. Select **Read KOEO Fast Codes** or **Read KOEO Slow Codes**.

- Use the ▲ **UP** and ▼ **DOWN** keys until the desired choice is highlighted.
- Press **ENTER**.

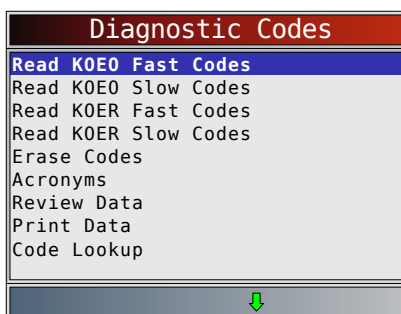

Follow the instructions step-by-step:

- Set parking brake.
- Transmission in park (P) or neutral (N).
- Turn A/C off.
- Start engine and let idle until hot.
- Turn ignition key off.
- Wait 10 seconds. Turn key on-engine off. Do not start engine.



CAUTION
Avoid cooling fan! It may turn on during test.

While waiting for the codes to transmit, the PCM cycles the following system components ON and OFF:

- Electric radiator cooling fan.
- Fuel pump.
- Check engine light or malfunction indicator light (MIL) - Slow Codes only.
- Idle speed control solenoid.

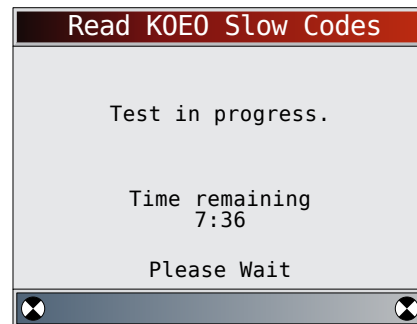

2. View and write down the DTCs.
 - Use the ▲ **UP** and ▼ **DOWN** keys until the desired choice is highlighted.
 - If no problems exist, Code 11 or 111 will be displayed.

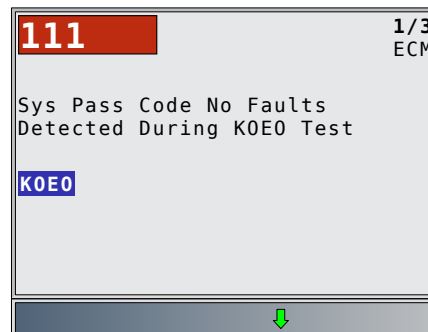

- ENG indicates that DTC is from the engine or powertrain control module.
- After viewing and noting the KOEO codes, press ▼ **DOWN** to view Continuous Memory codes.
- Continuous Memory Codes (codes set previously under normal driving conditions) are available after reading KOEO Codes. They are indicated as Memory Codes by the scan tool.

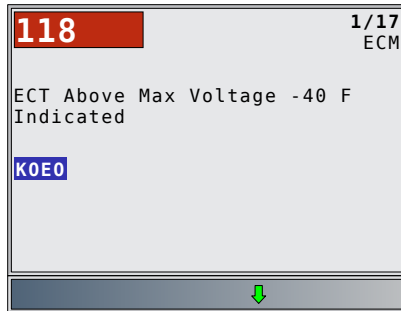

- Return to **Diagnostic Codes Menu**.
 - Press **BACK**.

Read KOER Fast Codes / Read KOER Slow Codes

The Read KOER Codes function activates the key on engine running (KOER) self-test which retrieves KOER DTCs that are present when the engine is running. When the trouble condition is inactive, the KOER code is no longer sent through the datastream.

The DTCs are transmitted in two formats which transmit the same information:

- Slow Codes are regular service codes that allow the user to identify the faults with an analog voltmeter or the check engine light. Slow codes are transmitted within 3 minutes.
- Fast Codes are transmitted within seconds and must be read with a diagnostic tool. MECS vehicles do not support Fast Codes.



WARNING

Exhaust gases are harmful or lethal. Always operate vehicle in a well-ventilated area.



CAUTION

The KOER test is done with the engine running. Do not over-rev engine. Observe all safety precautions.



CAUTION

Avoid cooling fan! It may turn on during test.

From **Diagnostic Codes Menu**:

- Select **Read KOER Fast Codes** or **Read KOER Slow Codes**.
 - Use the **▲ UP** and **▼ DOWN** keys until **Read KOER Codes** is highlighted.
 - Press **ENTER**.

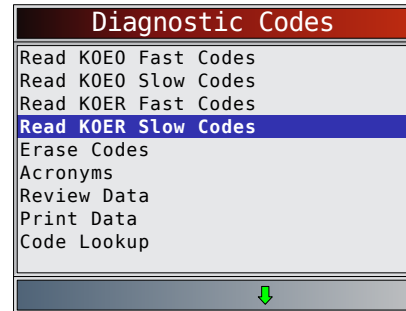

Follow the instructions step-by-step. Failure to perform these steps may set a false DTC in the PCM – observe the display.

- Set parking brake.
 - Transmission in park (P) or neutral (N).
 - Turn A/C off.
 - Start Engine and let idle until hot.
 - Turn ignition key off.
 - Wait 10 seconds. Start engine and let idle.
 - If vehicle is equipped with a manual transmission, release clutch.
- After performing steps, press **ENTER** to activate the self-test.
 - The following actions do not apply to MECS vehicles.
 - For a 7.3L Diesel, press the throttle until the test is done.
 - If applicable, set the octane switch to premium.
 - The scan tool prompts the user to:
 - Work steering wheel.
 - Pump brake pedal and cycle overdrive (OD) cancel switch. (Cycle overdrive only if a pushbutton is available.)
 - Observe screen for the prompt to perform the next action.
 - Quickly press and release throttle. One time only!
 - View and write down the DTCs.
 - Use the **▲ UP** and **▼ DOWN** keys to scroll to next DTC.

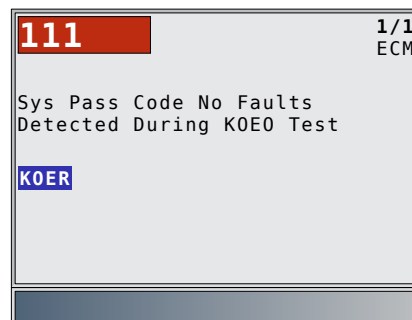

If no problems exist, Code 11 or 111 will be displayed. ENG indicates that DTC is from the engine or powertrain control module.

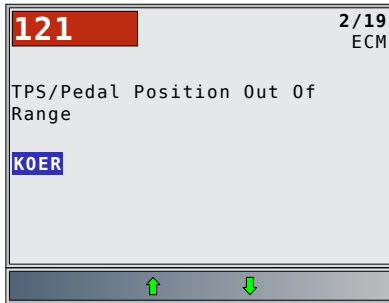

4. Return to **Diagnostic Codes Menu**.
 - Press **BACK**.

7.2 Erase Codes

The vehicle service manual may recommend erasing Continuous Memory Codes from the vehicle memory, and then driving the vehicle to duplicate the malfunction before beginning a diagnostic test. If KOEO codes were read using Fast Codes, the memory codes have already been erased.

EEC-IV Erase Codes

From **Diagnostic Codes Menu**:

1. Select **Erase Codes**.
 - Use the **▲ UP** and **▼ DOWN** keys until **Erase Codes** is highlighted.
 - Press **ENTER**.
 - Only Continuous Memory codes can be erased from the vehicle without repairing the fault. To remove KOEO and KOER codes, the fault must be repaired since they only exist when a fault exists.

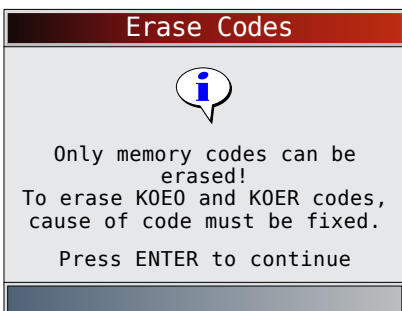
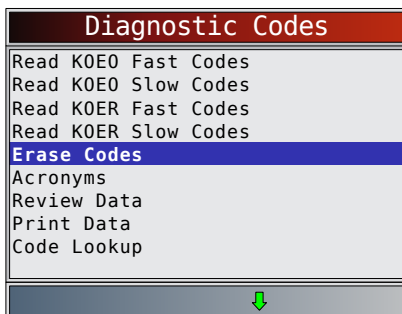

2. Perform the following:
 - Turn ignition key off.
 - Transmission in park (P) or neutral (N).

- Wait 10 seconds.
 - Turn ignition key on.
 - Press **ENTER** after each message.
3. Erase memory codes.
 - Press **ENTER** to begin erasing codes, which takes less than one minute to run.

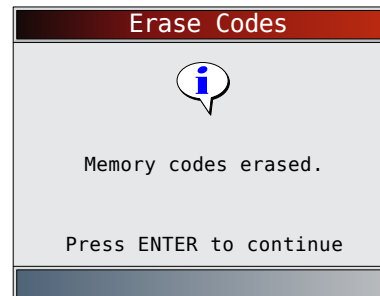
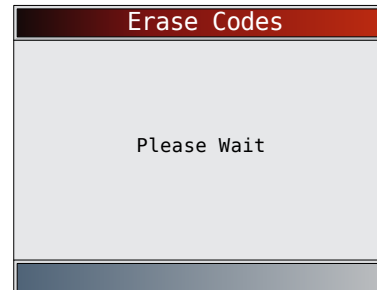

4. Return to **Diagnostic Codes Menu**.
 - Press **BACK**.

MECS Erase Codes

From **Diagnostic Codes Menu**:

1. Select **Erase Codes**.
 - Use the **▲ UP** and **▼ DOWN** keys until **Erase Codes** is highlighted.
 - Press **ENTER**.

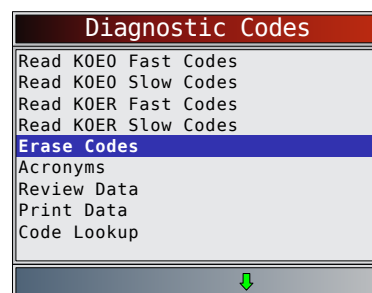

2. Perform the following:
 - Turn ignition key off.
 - Disconnect negative (-) battery cable.
 - Hold down brake pedal for 10 seconds.
 - Connect negative (-) battery cable.

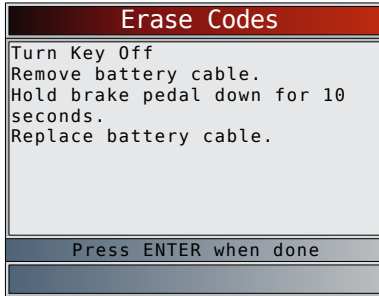

3. Return to **Diagnostic Codes Menu**.

- Press **BACK**
- or
- press **ENTER**.

7.3 IVSC-Speed Ctrl (EEC-IV Vehicles)

The IVSC-Speed Ctrl (Integrated Vehicle Speed Control) is Ford's computerized cruise control system on EEC-IV vehicles. It is controlled by the PCM and contains a dedicated network of sensors, switches, and actuators. Both KOEO and KOER codes exist for this test. The tool provides the ability to diagnose problems by reading DTCs.

Reading IVSC KOEO Codes

From **Diagnostic Codes Menu**:

1. Select **IVSC KOEO Codes**.
 - Use the **▲ UP** and **▼ DOWN** keys until **IVSC KOEO Codes** is highlighted.
 - Press **ENTER**.

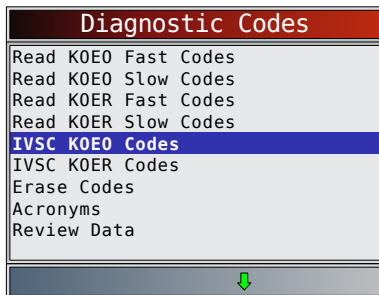

2. Perform the following:
 - Set parking brake.
 - Transmission in park (P) or neutral (N).
 - Turn A/C off.
 - Start engine and let idle until hot.
 - Turn ignition key off.
 - Wait 10 seconds. Turn key on engine off. Do not start engine.



CAUTION

Avoid cooling fan! It may turn on during test.

During testing, it is very important that each required step be performed when prompted by the scan tool. Failure to perform these steps may set DTC(s) in the

PCM. During this test, the tool prompts the user to perform the following steps:

- Press speed control ON button.
 - Press speed control OFF, RESUME, COAST, and ACCEL buttons.
 - Tap brake and clutch pedals.
3. View and write down the DTCs.
 - Use the **▲ UP** and **▼ DOWN** keys to scroll to next DTC.
 - ENG indicates that DTC is from the engine or powertrain control module.

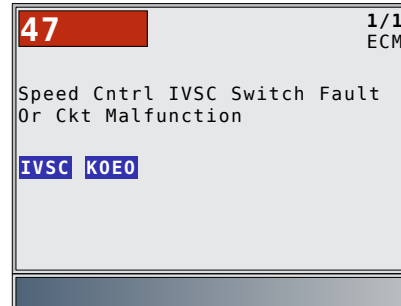

4. Return to **Diagnostic Codes Menu**.

- Press **BACK** twice.

Reading IVSC KOER Codes

From **Diagnostic Codes Menu**:

1. Select **IVSC KOER Codes**.
 - Use the **▲ UP** and **▼ DOWN** keys until **IVSC KOER Codes** is highlighted.
 - Press **ENTER**.

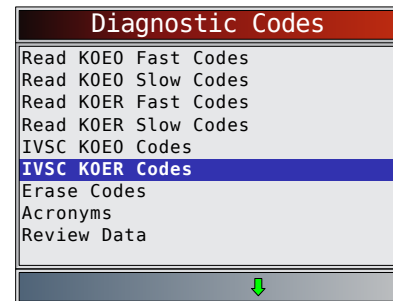

2. Perform the following:
 - Set parking brake.
 - Transmission in park (P) or neutral (N).
 - Turn A/C off.
 - Start engine and let idle until hot.
 - Turn ignition key off.
 - Wait 10 seconds. Start engine and let idle.

During testing, the scan tool prompts the user to press the vehicle's speed control ON button.



WARNING

Exhaust gases are harmful or lethal. Always operate vehicle in a well-ventilated area.



CAUTION

The Read KOER test is done with the engine running. Do not over-rev the engine. Observe all safety precautions.

During testing, it is very important that each required step be performed when prompted by the scan tool. Failure to perform these steps may set DTCs in the PCM. Be sure to observe the tool display for indications to perform these steps.

Do not touch the throttle pedal during testing. The user is reminded of this by the scan tool.

Once the codes have been read by the scan tool, it instructs the user to turn the ignition key off:

3. View and write down the DTCs.
 - Use the ▲ **UP** and ▼ **DOWN** keys to scroll to next DTC.
 - ENG indicates that DTC is from the engine or powertrain control module.

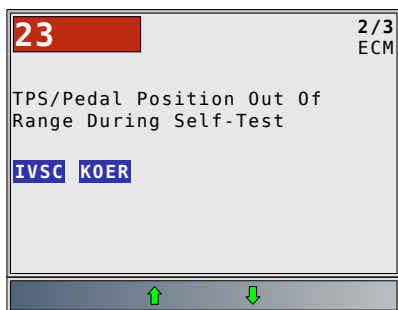

4. Return to **Diagnostic Codes Menu**.
 - Press **BACK** twice.

7.4 Wiggle Test (EEC-IV Vehicles)

The **Wiggle Test**, often referred to as the Continuous Monitor Test, is used to locate intermittent electrical faults on EEC-IV vehicles. When the test is activated, the tool beeps and displays a message when a fault is present. If the problem is fixed or goes away, the tone and message goes away. Refer to the applicable vehicle service manual for circuits that can be tested. If the Alert was turned off in the Tool Setup menu, it will be automatically activated for the **Wiggle Test**. Once the Wiggle Test is complete, the alert returns to its previous setting.

From **On Demand Tests Menu**:

1. Select **KOEO Wiggle Test** or **KOER Wiggle Test**.
 - Use the ▲ **UP** and ▼ **DOWN** keys until the desired choice is highlighted.
 - Press **ENTER**.

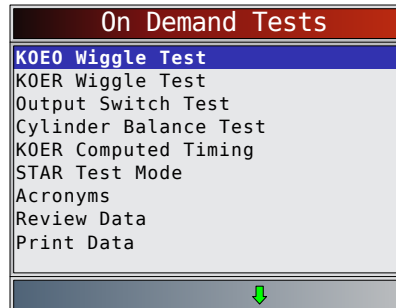

2. Perform the following:
 - Set parking brake.
 - Transmission in park (P) or neutral (N).
 - Turn A/C off.
 - Turn ignition key off and wait 10 seconds.
 - For KOEO: Turn key on engine off. Do not start engine. For KOER: Turn key on engine running and let idle.
3. Wiggle Test instructions:
 - Gently tap and shake the sensor.
 - Wiggle the sensor connectors.
 - Twist and shake the wiring between the sensor and the PCM.
 - Press **ENTER** to start KOEO/KOER wiggle test.

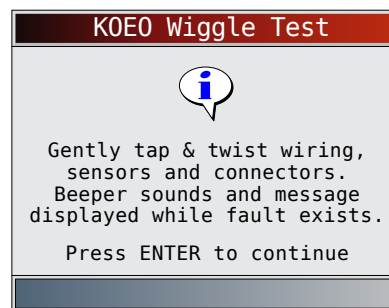

- After the 10-second initialization period, the tool is ready for the Wiggle Test. Locate the suspect sensor or circuit according to the above instructions.

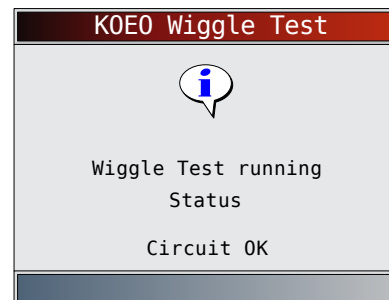

- If a fault is detected, the tool beeps and displays a **FAULT PRESENT** message. A Continuous Memory DTC(s) is stored in the PCM.

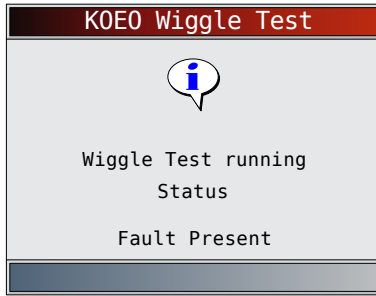

4. Return to **On Demand Tests Menu**.

- Press **BACK**.

Perform the “Read KOEO Fast Codes / Read KOEO Slow Codes” on page 6-5 to retrieve the Continuous Memory DTC(s) set during the wiggle test. After making all repairs, perform “Erase Codes” on page 6-10 to clear the Continuous Memory DTC.

7.5 Output Switch Test (EEC-IV Vehicles)

The Output Switch Test, also known as the Output State Check, is used to check the operation of the computer-controlled relays and solenoids on EEC-IV vehicles. The user can troubleshoot circuits using a voltmeter to measure voltage at the relays and solenoids in both energized and non-energized conditions. Record all measurements for reference.

- Fuel injectors are NOT energized during this test.
- On vehicles equipped with integrated vehicle speed control (IVSC), failure to disconnect the vacuum supply hose from the speed control servo energizes the speed control solenoids.

From **On Demand Tests Menu**:

1. Select **Output Switch Test**.
 - Use the **▲ UP** and **▼ DOWN** keys until **Output Switch Test** is highlighted.
 - Press **ENTER**.

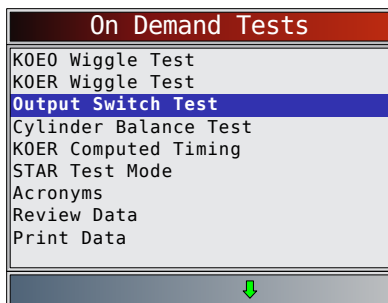

2. Perform the following:
 - Set parking brake.
 - Transmission in park (P) or neutral (N).
 - Turn A/C off.
 - Start engine and let idle until hot.
 - Turn ignition key off.
 - Wait 10 seconds.
 - Turn key on engine off. Do not start engine.



CAUTION

Avoid cooling fan! It may turn on during test.

The test screen indicates the time remaining. Do not touch vehicle or tools during this time until the next screen appears.

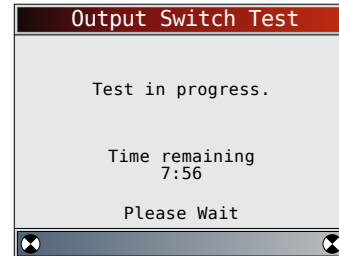

3. Toggle relays and solenoids.

- Press the accelerator pedal fully to turn on relays and solenoids. Do the same to turn them off. This can be repeated as many times as required to locate the fault.

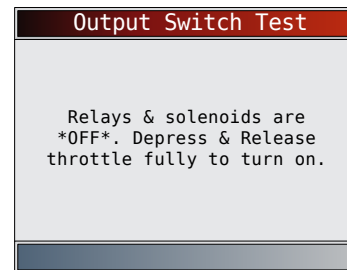

4. Return to **On Demand Tests Menu**.

- Turn the ignition key off.
- Press **BACK**.

7.6 Cylinder Balance Test (EEC-IV Vehicles)

The **Cylinder Balance Test** is only applicable to engines equipped with EEC-IV Sequential Electronic Fuel Injection (SEFI or SFI). The **Cylinder Balance Test** identifies a weak cylinder(s) on EEC-IV vehicles. A weak cylinder may be caused by low compression, poor valve seating, fouled spark plugs, damaged fuel injectors, and other cylinder faults. The PCM shuts off the fuel supply to each cylinder and measures the RPM drop. The PCM then calculates variations between cylinders thus identifying the weak ones.



WARNING

Exhaust gases are harmful or lethal. Always operate vehicle in a well-ventilated area.



CAUTION

The Cylinder Balance Test is done with the engine running. Do not over-rev the engine. Observe all safety precautions.

From **On Demand Tests Menu**:

1. Select **Cylinder Balance Test**.
 - Use the ▲ **UP** and ▼ **DOWN** keys until **Cylinder Balance Test** is highlighted.
 - Press **ENTER**.

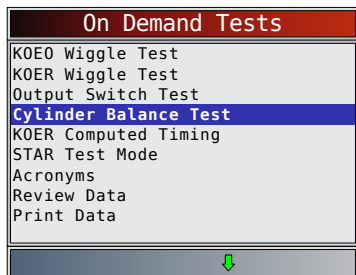

CAUTION

Keep hands and tools away from fan and engine during test.

2. Perform the following:
 - Set parking brake.
 - Transmission in park (P) or neutral (N).
 - Turn A/C off.
 - Start engine and let idle until hot.
 - Turn ignition key off.
 - Wait 10 seconds. Start engine and let idle.
 - If vehicle is equipped with a manual transmission, release clutch.
 - Press **ENTER** to continue.
3. Wait for the Cylinder ID.
 - Follow all user prompts:
 - Work Steering Wheel
 - Pump brake pedal and cycle overdrive (OD) cancel switch.
 - Observe the screen for the prompt to perform the next action.
 - Quickly press and release the throttle. One time only!
 - If no DTC is present, continue to Step 4. If any DTC(s) are present, the **Cylinder Balance Test** stops and the tool displays the DTCs.
4. Start **Cylinder Balance Test**.
 - Depress and release the throttle halfway within the next 1.5 minutes.
 - Press **ENTER** to continue.

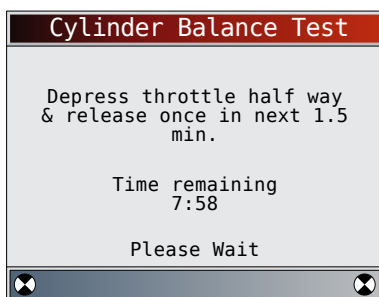

- Do not move the throttle.

- If throttle is moved after pressing and releasing the throttle, the tool displays an error message indicating the test failed due to throttle movement.
- Noise from the throttle position sensor (TPS) may cause the test to abort even though the throttle was not moved.

5. View test results.
 - If the engine operates properly, the screen below displays. Press **ENTER** to continue.

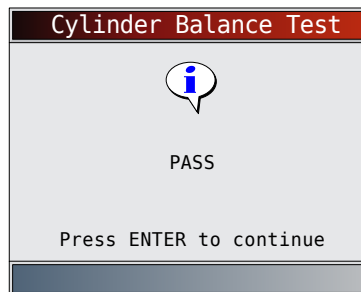

- If a problem exists with one or more cylinders, the tool displays a list of failed cylinder(s). Press **ENTER** to continue.
- Refer to the applicable vehicle service manual for cylinder numbering sequence. Cylinder failure may be caused by faulty injectors, sparks plugs, or wiring.

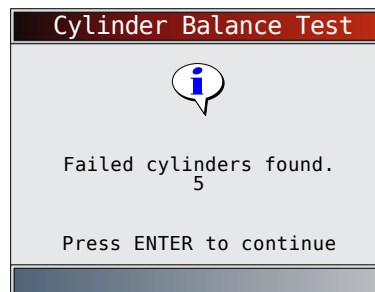

- Press **ENTER** to continue – the tool prompts the user to retest (up to three times). If required, rerun the test to double check the results, or to check for weaker or dead cylinders.
6. Return to **On Demand Tests Menu**.
 - Turn the ignition key off.
 - Press **BACK**.

7.7 KOER Computed Timing (1984-1991 EEC-IV Vehicles)

The **KOER Computed Timing** function allows you to check both the Base engine timing (no computer adjustment) and the ability of the computer to control spark advance.

- This does not apply to 7.3L diesel vehicles.
- Connect a timing light to the vehicle in accordance with the manufacturer's instructions. (For 2.3L dual plug engines, use exhaust side plug. Refer to ignition

system section in the appropriate service manual for specific instructions.)

From **On Demand Tests Menu**:

1. Select **KOER Computed Timing**.
 - Use the ▲ **UP** and ▼ **DOWN** keys until **KOER Computed Timing** is highlighted.
 - Press **ENTER**.

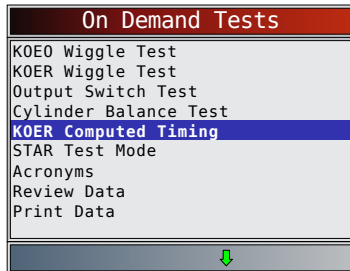

CAUTION

Avoid cooling fan! It may turn on during test.

2. Perform the following (Failure to perform these steps may set a false DTC in the PCM – observe the display):
 - Set parking brake.
 - Transmission in park (P) or neutral (N).
 - Turn A/C off.
 - Start engine and let idle until hot.
 - Turn ignition key off.
 - Wait 10 seconds. Start engine and let idle.
 - If vehicle is equipped with a manual transmission, release clutch.

If a KOER code of 98 or 998 is detected, then the fault must be fixed before performing this function. Press the **BACK** key to return to the Diagnostic Codes Menu.

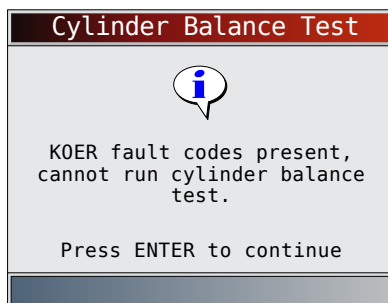

Otherwise, the timing remains fixed for 90 seconds to allow you to measure it with the Timing Light.

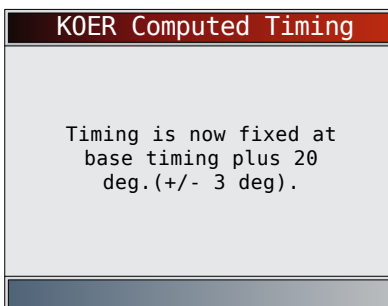

Computed timing is equal to the base timing plus 20 degrees before top dead center (BTDC) with 3 degrees of tolerance. The base timing value is printed on the Vehicle Emission Control Information (VECI) decal.

3. Return to **On Demand Tests Menu**.
 - Press **ENTER**.

7.8 STAR Test Mode (EEC-IV, MECS and MCU Vehicles)

The **STAR Test Mode** can be used to retrieve DTCs from the PCM or other self-test automatic readout (STAR) compatible controllers installed in the vehicle. **STAR Test Mode** functions largely the same way and serves the same purpose as running KOEO and KOER tests. It is generally used as a last resort to check for DTCs in systems which may not be covered by KOEO and KOER testing (such as computer ride control suspension systems).

From **On Demand Tests Menu**:

1. Select **STAR Test Mode**.
 - Use the ▲ **UP** and ▼ **DOWN** keys until **STAR Test Mode** is highlighted.
 - Press **ENTER**.

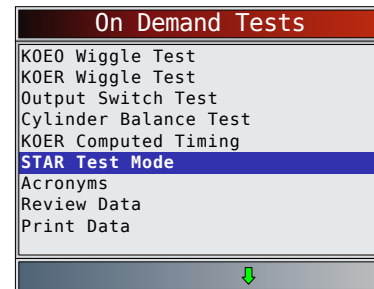

2. Follow the instructions on the tool screen to access DTCs from the PCM.
 - Pressing **ENTER** begins test.

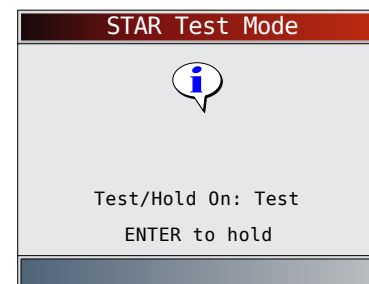

- The **TEST/HOLD** parameter indicates the state of the Self-Test Input (STI). **ENTER** toggles this state from **TEST** to **HOLD**.

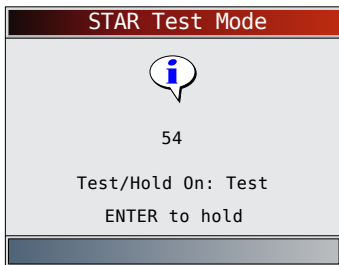

- With the STI in the TEST state, the self-test begins. A beep accompanies each time STO is low. When a completed 2-digit or 3-digit code is received, it is shown on the display. Write down the 2-digit or 3-digit code for reference.
 - If necessary, refer to the appropriate service manual for procedure on how to use **STAR Test Mode** for the specific vehicle under test.
3. Return to **On Demand Tests Menu**.
- Press **BACK**.

8 Chrysler OBD I Diagnostics

8.1 Diagnostic Menu



IMPORTANT
Review Data, Print Data, Code Lookup, Acronyms and System Setup are covered in Section 5 of this manual. These items are not covered in this section.

The **Chrysler Function List** is broken down into the following selections:

- Datastream
 - View Data
 - Record Data
 - Acronyms
 - Review Data
 - Print Data
 - Code Lookup
 - System Setup
- Diagnostic Codes
 - Read Codes
 - Erase Codes
 - Acronyms
 - Review Data
 - Print Data
 - Code Lookup
 - System Setup
- Acronyms
- Review Data
- Print Data
- Code Lookup
- System Setup

If an Error Message displays, make sure the adapter cable is securely attached and the ignition key is on. Cycle the ignition key to off for 10 seconds, then on. This may be required to reset the computer. If required, select yes to try again. If the problem still exists, refer to

”10.1 Error Messages” on page 61. Screens and functions may differ slightly for vehicle make and year.

8.2 View Data

The **View Data** function allows the user to view the vehicle Parameter Identification (PID) Data in real time. As the powertrain control module (PCM) monitors PIDs, they are simultaneously transmitted to the scan tool. The PIDs are continuously updated at the PCMs rate. In addition to reading codes, **View Data** is the most useful diagnostic function for isolating the cause of a vehicle operation problem. Viewing data is also used for observing sensor data and the ON/OFF state of switches, solenoids, and relays.

View Data can be performed with the ignition key on-engine off (KOEO) or key on engine running (KOER).



CAUTION
Two people must be in vehicle when driving. One to drive and the other to operate the scan tool.

From **Datastream Menu**:

1. Select **View Data**.
 - Use the **▲ UP** and **▼ DOWN** keys until **View Data** is highlighted.
 - Press **ENTER**.

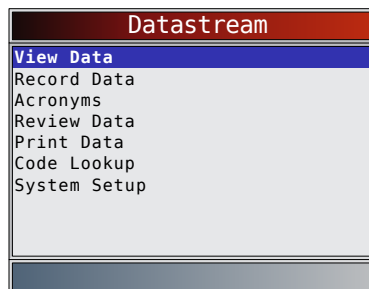

CAUTION
Keep hands and tools away from fan and engine during test.

On 1999 and newer vehicles, a screen may ask you to select engine data or transmission data. Some vehicles display a Select Group screen for viewing data. In these cases, only one group of data can be viewed at a time.

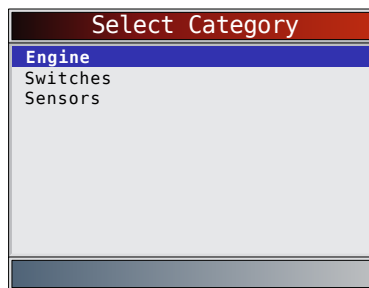

2. Select the type of data to view.

- Use the ▲ **UP** and ▼ **DOWN** keys until desired choice is highlighted. For additional View Data information, refer to "5 OBD II Diagnostics" on page 26.
- Press **ENTER**.

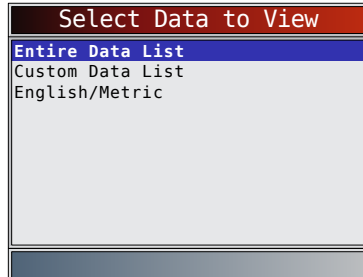

- View PIDs on scan tool.
 - Use the ▲ **UP** and ▼ **DOWN** keys.
 - A n/a or "- -" indicates the PID is not used by the vehicle.

A/C PRES (PSI)	500.1
A/C PRES(V)	5.00
ADD FUEL(uS)	8
ADPT FUEL(%)	0.0
BATT TEMP(°F)	73
BATT TEMP(V)	1.86
BATTERY(V)	12.4
CHRG GOAL(V)	13.8
CNG PRES(PSI)	255.0
CNG TEMP(°F)	4
COOLANT(V)	5.00

- Change the selection of Custom Data List parameters.
 - Press **BACK**.
- Return to **Datastream Menu**.
 - Press **BACK**.

8.3 Record Data

The **Record Data** function records vehicle PID data while the vehicle is parked or being driven. This function is mainly used for diagnosing intermittent driveability problems that cannot be isolated by any other method.

The **Record Data** function allows diagnosis of an intermittent problem by analyzing data leading up to the problem, during the problem, and possibly after the problem, depending on duration.

From **Datastream Menu**:

- Select **Record Data**.
 - Use the ▲ **UP** and ▼ **DOWN** keys until **Record Data** is highlighted.

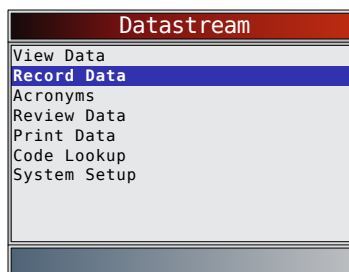

- The scan tool can maintain 5 recordings per vehicle. If there are already 5 recordings stored, the scan tool will ask which recording to overwrite.
- On 1999 and newer vehicles, a screen may ask you to select Engine Data or Transmission Data.
- Next, turn the ignition key on. Engine can be off or running.

- Refer to "5.7 Record Data" on page 34.

8.4 Read Codes

The **Read Codes** function enables the scan tool to retrieve and display any specific emission-related diagnostic trouble codes (DTCs) stored in vehicle's memory. This function can be performed key on engine off (KOEO) or key on engine running (KOER):

From the **Diagnostic Codes Menu**:

- Select **Read Codes**.
 - Use the ▲ **UP** and ▼ **DOWN** keys until **Read Codes** is highlighted.
 - Press **ENTER**.

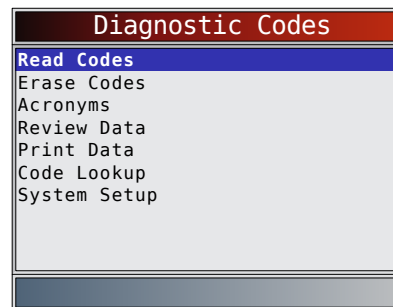

CAUTION

Keep hands and tools away from fan and engine during test.

The scan tool retrieves DTCs. If no DTCs are present, a message stating "No codes found" is displayed.

- View and write down the DTCs.
 - Use the ▲ **UP** and ▼ **DOWN** keys to scroll through the DTCs.

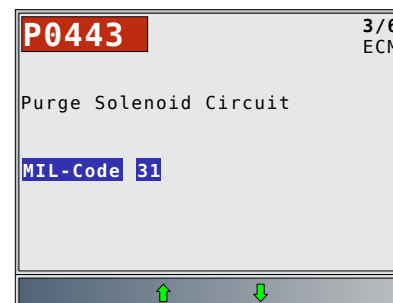

- The DTCs are categorized by ECM (Engine control module). The Chrysler MIL code (3-digit) and SAE code (5-digit) follow.
- Temporary Codes are supported on vehicles equipped with JTEC and SBEC version III modules. Temporary Codes are DTCs that failed one

trip but did not turn on the MIL light. If the vehicle does not support this function, then the tool will not display it.

3. Return to **Diagnostic Codes Menu**.

- Press **BACK**.

8.5 Erase Codes

The **Erase Codes** function deletes DTCs and resets I/M Monitor data from vehicle's control module(s). Perform this function only after the systems have been checked completely and DTCs have been documented. This function should be performed KOEO. Do not start engine. After servicing the vehicle, erase stored DTCs and verify no codes have returned. If a DTC returns, problem has not been fixed or other faults are present.

From **Diagnostic Codes Menu**:

1. Select **Erase Codes**.

- Use the ▲ **UP** and ▼ **DOWN** keys until **Erase Codes** is highlighted.
- Press **ENTER**.

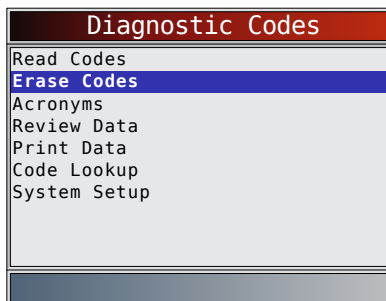

2. Follow the instructions.

- Press **ENTER**.

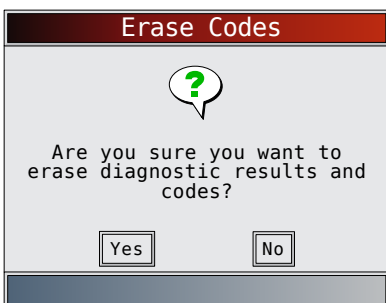

- After the Erase Codes command is transmitted to the vehicle, a "Command sent" message is displayed.
- Press **ENTER**.

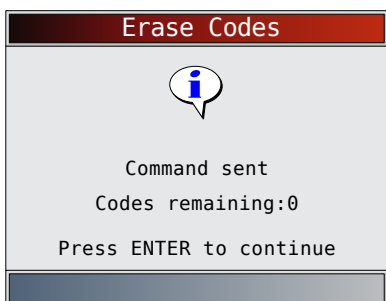

3. Return to **Diagnostic Codes Menu**.

- Press **BACK**.

9 Toyota OBD I Diagnostics

9.1 Diagnostic Menu

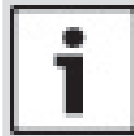

IMPORTANT

View Data, Record Data, Review Data, Print Data, Code Lookup, Acronyms and System Setup are covered in section 5 of this manual. These items are not covered in this section.

The **Toyota Function List** is broken down into the following selections:

- Datastream
 - View Data
 - Record Data
 - Acronyms
 - Review Data
 - Print Data
 - Code Lookup
 - System Setup
- Diagnostic Codes
 - Read Codes
 - Erase Codes
 - Acronyms
 - Review Data
 - Print Data
 - Code Lookup
 - System Setup
- Acronyms
- Review Data
- Print Data
- Code Lookup
- System Setup

If an Error Message displays, make sure the adapter cable is securely attached, and the ignition key is on. Cycle the ignition key to off for 10 seconds, then on. This may be required to reset the computer. If required, select yes to try again. If the problem still exists, refer to "10.1 Error Messages" on page 61.

9.2 Read Codes

The **Read Codes** function allows the scan tool to read the DTCs from the vehicle's control modules. DTCs are used to help determine the cause of a problem or problems with a vehicle. These codes cause the control module to illuminate the malfunction indicator lamp (MIL) when emission-related or driveability fault occurs. MIL is also known as service engine soon or check engine lamp:

From the **Diagnostic Codes Menu**:

1. Select **Read Codes**.

- Use the ▲ **UP** and ▼ **DOWN** keys until **Read Codes** is highlighted.
- Press **ENTER**.

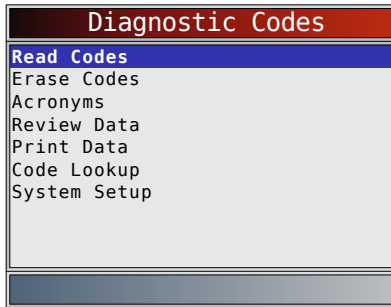

2. Follow the instructions step-by-step:
 - Set parking brake.
 - Transmission in park (P) or neutral (N).
 - Turn A/C off.
 - Start engine and let idle until hot.
 - Turn ignition key off.
 - Wait 10 seconds. Turn key on-engine off. Do not start engine.

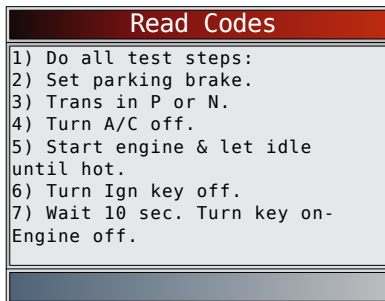

Wait for the ECM to transmit the codes. Once the codes start coming, the scan tool will read them. Wait until all codes have been received.

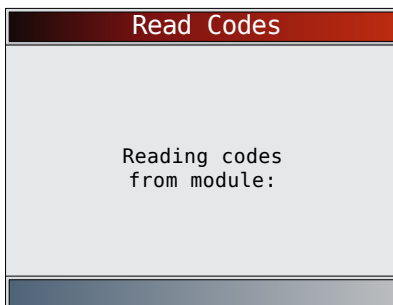
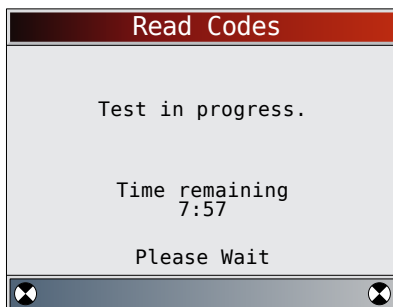

If no DTCs are present, a message stating “No codes found” is displayed.

3. View and write down the DTCs.
 - Use the ▲ **UP** and ▼ **DOWN** keys to scroll through the DTCs.

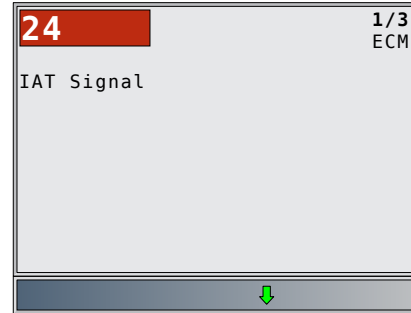

4. Return to **Diagnostic Codes Menu**.
 - Press **BACK**.

9.3 Erase Codes

The scan tool can't erase codes on Toyota OBD I, but it can display instructions on how to manually erase the codes.

From the **Diagnostic Codes Menu**:

1. Select **Erase Codes**.
 - Use the ▲ **UP** and ▼ **DOWN** keys until **Erase Codes** is highlighted.
 - Press **ENTER**.

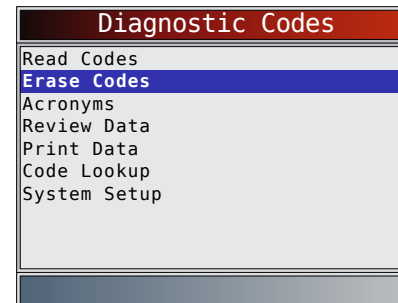

2. To erase codes, follow the instructions displayed.
 - Press **ENTER** to return to the **Diagnostic Codes Menu**.

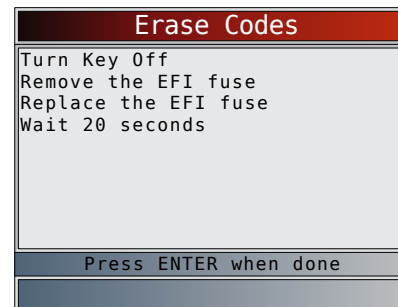

10 Troubleshooting

10.1 Error Messages

Check the following if an error message displays:

- Verify ignition key is in the ON and not in the ACCESSORIES position.
- Make sure the DLC Cable is attached to vehicle's data link connector (DLC) and scan tool.

- Look at DLC and check for cracked or recessed pins, or for any substance that could prevent a good electrical connection.
- Test for continuity between the DLC wiring and the computer. In an extreme case, there may be a broken wire.
- Check for bent or broken pins.
- With the engine off, check for blown fuses in the vehicle fuse box.
- Make sure the vehicle's control module has a good ground. If the computer case is grounded, then clean the connection and apply a conductive (dielectric) grease to the mating surfaces.
- With the key on engine off (KOEO), verify vehicle battery voltage is at least 8.0V.
- Verify the control module is not defective. Refer to the service manual to diagnose the control module.

10.2 Scan Tool Does Not Power Up



WARNING

Review Safety Messages on page 5 before troubleshooting.

If scan tool will not power up, communicate with vehicle control module, pass scan tool self-tests, or functions incorrectly in any other way, do the following:

- Check and replace the batteries if needed.
- Clean the DLC pins.
- Disconnect and reconnect DLC making sure it is connected correctly.
- Check vehicle battery to make sure at least 8.0 volts is present.
- Contact customer service.
- With the engine off, check for blown fuses in the vehicle fuse box.

10.3 Vehicle Communication Fault

The vehicle's control module(s) enters into an unrecoverable state.

1. Turn vehicle key to off position.
 - Wait 10 seconds.
 - Press **ENTER**.



10.4 Operating Error or Erroneous Data

An Operating Error or Erroneous Data occurs if vehicle's computer(s) stop(s) communicating with the scan tool.

1. Make selection.
 - Use the **LEFT** and **RIGHT** keys.
 - Press **ENTER**.



10.5 Battery Replacement

The scan tool requires 4-AAA alkaline batteries to operate without vehicle power.

- When the batteries need to be replaced, the low-battery icon (⎓) is displayed.
 - Rechargeable batteries do not last as long as alkaline types and are not recommended.
 - Non-rechargeable Lithium (Li) battery can be used. Lithium types last longer than the alkaline types, but they are more expensive.
1. Place display face-down on a non-abrasive surface.
 2. Remove battery cover by turning phillips screw counterclockwise. Slide battery cover off.
 3. Remove batteries and properly discard.
 4. Install four new AAA Alkaline batteries.
 5. Reinstall battery cover by sliding battery cover on. Install phillips screw turning it clockwise. Do not overtighten screw.



10.6 Tool Self-Tests

Tool Self-Tests check the display, keys, and internal memory.

- Refer to "4 Using the Scan Tool" on page 12 for the operation procedures for scan tool self-tests.

10.7 Technical Support

Toll-Free Number: 1-800-228-7667.

11 Appendix A—Global OBD II PID Definitions

Although there are in excess of 300 PIDs, the tool only displays the PIDs the vehicle supports.

PID	PID Description
ABS FRP	Absolute Fuel Rail Pressure
ABS LOAD	Absolute Load Value
ABS TPS B, C	Throttle Position B, C
ABSLT TPS	Absolute Throttle Position
ACC POS D	Accelerator Pedal D, E, F
ACC POS REL	Relative Accelerator Pedal Position
AECD1_TIME1, TIME 2	Total Run Time with EI-AECD #1 Timer 1 Active, #2 Timer Active
AECD10_TIME1, TIME 2	Total Run Time with EI-AECD #10 Timer 1 Active, #2 Timer Active
AECD11_TIME1, TIME 2	Total Run Time with EI-AECD #11 Timer 1 active, #2 Timer Active
AECD12_TIME1, TIME 2	Total Run Time with EI-AECD #12 Timer 1 active, #2 Timer Active
AECD13_TIME1, TIME 2	Total Run Time with EI-AECD #13 Timer 1 active, #2 Timer Active
AECD14_TIME1, TIME 2	Total Run Time with EI-AECD #14 Timer 1 active, #2 Timer Active
AECD15_TIME1, TIME 2	Total Run Time with EI-AECD #15 Timer 1 active, #2 Timer Active
AECD16_TIME1, TIME 2	Total Run Time with EI-AECD #16 Timer 1 active, #2 Timer Active
AECD17_TIME1, TIME 2	Total Run Time with EI-AECD #17 Timer 1 active, #2 Timer Active
AECD18_TIME1, TIME 2	Total Run Time with EI-AECD #18 Timer 1 active, #2 Timer Active
AECD19_TIME1, TIME 2	Total Run Time with EI-AECD #19 Timer 1 active, #2 Timer Active
AECD2_TIME1, TIME 2	Total Run Time with EI-AECD #2 Timer 1 Active, #2 Timer Active
AECD20_TIME1, TIME 2	Total Run Time with EI-AECD #20 Timer 1 active, #2 Timer Active
AECD3_TIME1, TIME 2	Total Run Time with EI-AECD #3 Timer 1 Active, #2 Timer Active
AECD4_TIME1, TIME 2	Total Run Time with EI-AECD #4 Timer 1 Active, #2 Timer Active
AECD5_TIME1, TIME 2	Total Run Time with EI-AECD #5 Timer 1 Active, #2 Timer Active
AECD6_TIME1, TIME 2	Total Run Time with EI-AECD #6 Timer 1 Active, #2 Timer Active
AECD7_TIME1, TIME 2	Total Run Time with EI-AECD #7 Timer 1 Active, #2 Timer Active
AECD8_TIME1, TIME 2	Total Run Time with EI-AECD #8 Timer 1 Active, #2 Timer Active
AECD9_TIME1, TIME 2	Total Run Time with EI-AECD #9 Timer 1 Active, #2 Timer Active
ALCOHOL	Alcohol Fuel Percent
BARO PRS	Barometric Pressure
BAT_PWR	Hybrid Battery Pack Remaining Life

PID	PID Description
BP_A_ACT, B_ACT	Boost Pressure Sensor A, Sensor B
BP_A_CMD, B_CMD	Commanded Boost Pressure A, Pressure B
BP_A_STAT, B_STAT	Boost Pressure A Control Status, B Control Status
CACT 11, 12	Charge Air Cooler Temperature Bank 1 Sensor 1 supported, Sensor 2 supported
CACT 21,22	Charge Air Cooler Temperature Bank 2 Sensor 1 supported, Sensor 2 supported
CALC LOAD	Calculated Engine Load
CAT TEMP11, TEMP12	Catalytic Converter Temp Bank1, Temp Bank 3
CAT TEMP21, TEMP22	Catalytic Converter Temp Bank2, Temp Bank 4
CLR DIST	Distance since erase
CLR TIME	Minutes Run since Erase
CLR TRPS	Warmups Since Erase
CMD EQ RAT	Commanded Equivalence Ratio
COOLANT	Engine Coolant Temp
DPF_REG_AVGD	Average Distance Between DPF Regen
DPF_REG_AVGT	Average Time Between DPF Regen
DPF_REG_STAT	Diesel Particulate Filter (DPF) Regen Status
DPF_REG_TYP	Diesel Particulate Filter (DPF) Regen Type
DPF_REGEN_PCT	Normalized Trigger for DPF Regen
DPF1_DP, DPF2_DP	Diesel Particulate Filter (DPF) Bank 1 Delta Pressure Bank 2 Delta Pressure
DPF1_INP, DPF2_INP	Diesel Particulate Filter (DPF) Bank 1 Inlet Pressure, Bank 2 Inlet Pressure
DPF1_INT, DPF2_INT	DPF Bank 1 Inlet Temperature Sensor, Bank 2 Inlet Temperature Sensor
DPF1_OUTP, DPF2_OUTP	Diesel Particulate Filter (DPF) Bank 1 Outlet Pressure, Bank 2 Outlet Pressure
DPF1_OUTT, DPF2_OUTT	DPF Bank 1 Outlet Temperature Sensor, Bank 2 Outlet Temperature Sensor
ECT 1, 2	Engine Coolant Temperature 1, Temperature 2
EGR CMD	Comanded EGR
EGR ERR	Exhaust Gas Recirculation Error
EGR_A_ACT, B_ACT	Actual EGR A Duty Cycle/Position, B Duty Cycle/Position
EGR_A_CMD, B_CMD	Commanded EGR A Duty Cycle/Position, B Duty Cycle/ Position
EGR_A_ERR, B_ERR	EGR A Error, B Error
EGRT 11, 21	Exhaust Gas Recirculation Temperature Bank 1 Sensor 1, Bank 2 Sensor 1
EGRT 12, 22	Exhaust Gas Recirculation Temperature Bank 1 Sensor 2, Bank 2 Sensor 2
EGT 11, 21	Exhaust Gas Temperature (EGT) Bank 1 Sensor 1, Bank 2 Sensor 1
EGT 12, 22	Exhaust Gas Temperature (EGT) Bank 1 Sensor 2, Bank 2 Sensor 2

PID	PID Description
EGT 13, 23	Exhaust Gas Temperature (EGT) Bank 1 Sensor 3, Bank 2 Sensor 3
EGT 14, 24	Exhaust Gas Temperature (EGT) Bank 1 Sensor 4, Bank 2 Sensor 4
EMIS_SUP	Emission requirements to which vehicle is designed
ENG RUN	Time Since Engine Start
ENG SPEED	Engine RPM
EOT	Engine Oil Temperature
EP_1, 2	Exhaust Pressure Sensor Bank 1, Bank 2
EQ RATIO	Equivalence Ratio
EVAP PURGE	Commanded EVAP Purge
EVAP VP	EVAP Vapor Pressure
EVAP VPA	Absolute EVAP Vapor Pressure
FRP_A, B	Fuel Rail Pressure A, B
FRP_A_CMD, B_CMD	Commanded Fuel Rail Pressure A, B
FRT_A, B	Fuel Rail Temperature A, B
FUEL LEVEL	Fuel Level Input
FUEL PRES	Fuel Rail Pressure
FUEL SYS 1, 2	Fuel System 1 Loop Status, System 2 Loop Status
FUEL TYPE	Fuel Type
FUEL_RATE	Engine Fuel Rate
FUEL_TIMING	Fueling Injection Timing
GPL_STAT	Glow Plug Lamp Status
IAF_A_CMD, B_CMD	Commanded Intake Air Flow A Control, B Control
IAF_A_REL, B_REL	Relative Intake Air Flow A Position, B Position
IAT	Intake Air Temp
IAT 11, 21	Intake Air Temperature Sensor Bank 1 Sensor 1, Bank 2 Sensor 1
IAT 12, 22	Intake Air Temperature Sensor Bank 1 Sensor 2, Bank 2 Sensor 2
IAT 13, 23	Intake Air Temperature Sensor Bank 1 Sensor 3, Bank 2 Sensor 3
ICP_A, B	Injection Control Pressure A, B
ICP_A_CMD, B_CMD	Commanded Injection Control Pressure A, B
IDLE_TIME	Total Idle Run Time
IGN ADV	Timing Advance
LAMBDA11, 21	O2 Sensor Lambda Bank 1 Sensor 1, Bank 2 Sensor 1
LAMBDA12, 22	O2 Sensor Lambda Bank 1 Sensor 2, Bank 2 Sensor 2
LT FTRM1	Long Term Fuel Trim 1 or 3
LT FTRM2	Long Term Fuel Trim 2 or 4
LT SEC FT1, 2, 3, 4	Long Term Secondary O2 Sensor Fuel Trim 1, 2, 3, 4
MAF, A, B	Mass Air Flow, A, B
MAP, A, B	Manifold Absolute Pressure, A, B
MIL DIST	MIL_DIST
MIL STATUS	Malfunction Indicator Lamp
MIL TIME	Minutes Run by MIL activated

PID	PID Description
MST	Manifold Surface Temperature
N/D_STAT	Auto Trans Neutral Drive Status
N/G_STAT	Manual Trans Neutral Gear Status
NNTE_Stat	NOx NTE control area status
NOX 11, 21	NOx Sensor Concentration Bank 1 Sensor 1, Bank 2 Sensor 1
NOX 12,22	NOx Sensor Concentration Bank 1 Sensor 2, Bank 2 Sensor 2
NOX LEVEL HI, HI1, HI2, HI3, HI4	SCR inducement system actual state 10K history HI1 (0-10000 km), 10K history HI2 (10000-20000 km), 10K history HI3 (20000-30000 km), 10K history HI4 (30000-40000 km): NOx emission too high
NOX_ADS_DE-SUL	NOx Adsorber Desulfurization Status
NOX_ADS_RE-GEN	NOx Adsorber Regen Status
NWI_TIME	Total Run Time by the Engine which NOx warning mode is activated
O2S	O2 Voltage or Current indicates Bank/Sensor
O2S11_PCT, O2S21_PCT	O2 Sensor Concentration Bank 1 Sensor 1, Bank 2 Sensor 1
O2S12_PCT, O2S22_PCT	O2 Sensor Concentration Bank 1 Sensor 2, Bank 2 Sensor 2
OBD2_STAT	OBD Status
OUT TEMP	Ambient Air Temp
PM 11, PM 21	PM Sensor Mass Concentration Bank 1 Sensor 1, Bank 2 Sensor 1
PNTE_Stat	PM NTE control area status
PTO STATUS	PTO Status
PTO_STAT	Power Take Off (PTO) Status
PTO_TIME	Total Run Time With PTO Active
REAG_DEMD	Average Demanded Reagent Consumption
REAG_LVL	Reagent Tank Level
REAG_RATE	Average Reagent Consumption
REL FRP	Relative Fuel Rail Pressure
REL TPS	Relative Throttle Position
RUN_TIME	Total Engine Run Time
SCR REAG DEV, DEV1, DEV2, DEV3, DEV4	SCR inducement system actual state 10K history DEV1 (0 - 10000 km), 10K history DEV2 (10000 - 20000 km), 10K history DEV3 (20000 - 30000 km), 10K history DEV4 (30000 - 40000 km): deviation of reagent consumption
SCR REAG LOW, LOW1, LOW2, LOW3, LOW4	SCR inducement system actual state 10K history LOW1 (0 - 10000 km), 10K history LOW2 (10000 - 20000 km), 10K history LOW3 (20000 - 30000 km), 10K history LOW4 (30000 - 40000 km): reagent level too low
SCR RE-AG WRONG, WRONG1, WRONG2, WRONG3, WRONG4	SCR inducement system actual state 10K history WRONG1 (0 - 10000 km), 10K history WRONG2 (10000 - 20000 km), 10K history WRONG3 (20000 - 30000 km), 10K history WRONG4 (30000 - 40000 km): incorrect reagent

PID	PID Description
SCR_SYS_ACTIVE	SCR inducement system actual state: inducement system active
SCR_DIST_1D	Distance travelled in current 10K block (0 - 10000 km)
SCR_DIST_1N, 2N, 3N, 4N	Distance travelled while inducement system active in current 10K block 1N (0 - 10000 km), 20K block 2N (10 - 20000 km), 30K block 3N (20 - 30000 km), 40K block 4N (30 - 40000 km)
SECOND AIR	Secondary Air Status
ST_FTRM	Fuel Trim Bank / Sensor
ST_FTRM1, 3	Short Term Fuel Trim1 or 3
ST_FTRM2, 4	Short Term Fuel Trim2 or 4
ST_SEC_FT1, 2, 3, 4	Short Term Secondary O2 Sensor Fuel Trim 1, 2, 3, 4
TAC_A_CMD, B_CMD	Commanded Throttle Actuator A Control, B Control
TAC_A_REL, B_REL	Relative Throttle A Position, B Position
TCA_CINP, TCB_CINP	Turbocharger Compressor Inlet Pressure Sensor A, Pressure Sensor B
TCA_CINT, TCB_CINT	Turbocharger A Compressor Inlet Temperature, Turbocharger B
TCA_COUTT, TCB_COUTT	Turbocharger A Compressor Outlet Temperature, Turbocharger B
TCA_RPM, TCB_RPM	Turbocharger A RPM, B RPM
TCA_TOUTT, TCB_TOUTT	Turbocharger A Turbine Outlet Temperature, Turbocharger B
TCA_TINT, TCB_TINT	Turbocharger A Turbine Inlet Temperature, Turbocharger B
THROT_CMD	Commanded Throttle Actuator Control
TP_G	Absolute Throttle Position G
TQ_ACT	Actual Engine - Percent Torque
TQ_DD	Driver's Demand Engine - Percent Torque
TQ_MAX1, MAX2, MAX3, MAX4, MAX5	Engine percent torque at idle point 1, 2, 3, 4, 5
TQ_REF	Engine Reference Torque
TROUB_CODE	Code causing the Freeze Frame
VEH_SPEED	Vehicle Speed
VGT_A_ACT	Variable geometry turbo A position
VGT_A_ACT, B_ACT	Variable Geometry Turbo A Position, Turbo B
VGT_A_CMD	Commanded variable geometry turbo A position
VGT_A_CMD, B_CMD	Commanded Variable Geometry Turbo A Position, Turbo B
VGT_A_STAT	Variable geometry turbo A control status
VGT_A_STAT, B_STAT	Variable Geometry Turbo A Control Status, Turbo B
VGT_B_ACT	Variable geometry turbo B position
VGT_B_CMD	Commanded variable geometry turbo B position
VGT_B_STAT	Variable geometry turbo B control status
VPWR	Control Module Voltage

PID	PID Description
WG_A_ACT	Wastegate A position
WG_A_ACT, B_ACT	Wastegate A Position, B Position
WG_A_CMD	Commanded wastegate A control
WG_A_CMD, B_CMD	Commanded Wastegate A Control, B Control
WG_B_ACT	Wastegate B position
WG_B_CMD	Commanded wastegate B control

12 Appendix B—Glossary

A/C:

Air conditioner

A/D:

Analog to digital

A/F:

Air/Fuel ratio. The proportion of air and fuel delivered to the cylinder for combustion. For example, an A/F ratio of 14:1 denotes 14 times as much air as fuel in the mixture. Ideally the A/F ratio is 14.7:1.

ABS:

Anti-lock brake system

A/C clutch relay:

The PCM uses this relay to energize the A/C clutch, turning the A/C compressor on or off.

A/C pressure sensor:

Measures air conditioning refrigerant pressure and sends a voltage signal to the PCM.

A/C pressure switch:

A mechanical switch connected to the A/C refrigerant line. The switch is activated (sending a signal to the PCM) when the A/C refrigerant pressure becomes too low or high.

Actuator:

Actuators such as relays, solenoids, and motors allow the PCM to control the operation of vehicle systems.

Air Injection Reaction (AIR) System:

An emission control system operated by the PCM. During cold starts, an air pump injects outside air into the exhaust manifold to help burn hot exhaust gases. This reduces pollution and speeds warm-up of oxygen sensors and catalytic converters. After the engine is warm, the air will either be dumped back to the atmosphere (or into the air cleaner assembly) or sent to the catalytic converter.

APP:

Acceleration pedal position (sensor)

ASR:

Acceleration slip regulation

Bank x:

The standard way of referring to the bank of cylinders containing cylinder #x. In-line engines have only one bank of cylinders. Most commonly used to identify the location of oxygen sensors. See O2S, Sensor x, Sensor x.

BARO:

Barometric pressure sensor. See MAP sensor.

BBV:

Brake boost vacuum (sensor)

BCM:

Body control module

Boost control solenoid:

A solenoid that is energized by the PCM, in order to control turbo/supercharger boost pressure.

Brake switch signal:

An input signal to the PCM indicating that the brake pedal is being pressed. This signal is typically used to disengage cruise control systems and torque converter clutch (TCC) solenoids. See also TCC.

CAM:

Camshaft position sensor. Sends a frequency signal to the PCM to synchronize fuel injector and spark plug firing.

Catalytic converter:

Designed to reduce exhaust emissions.

CAN:

Controller area network

CARB:

California air resources board. Governing body for emissions control in California.

CKP REF:

Crankshaft position reference.

CKP:

Crankshaft position. See CPS.

CKT:

Circuit

Closed loop (CL):

A feedback system that uses the O2 Sensor(s) to monitor the results of combustion. Based on the signal(s) from the O2 sensor(s), the PCM modifies the air/fuel mixture to maintain optimum performance with lowest emissions. In closed loop mode, the PCM can fine tune control of a system to achieve an exact result.

CMP:

Camshaft position sensor

CO:

Carbon monoxide; odorless gas produced by incomplete combustion.

Code scanner:

A device that interfaces with and communicates information via a data link.

Continuous memory codes:

See pending codes.

CPS:

Crankshaft position sensor. Sends a frequency signal to the PCM. It is used to reference fuel injector operation and synchronize spark plug firing on distributorless ignition systems (DIS).

CTS:

Coolant temperature sensor. A resistance sensor that sends a voltage signal to the PCM indicating the temperature of the coolant. This signal tells the PCM whether the engine is cold or warm.

CVRTD:

Continuous variable real time damping

D/R:

Drive/reverse

Data Link Connector (DLC):

Connector providing access and/or control of the vehicle information, operating conditions, and diagnostic information. Vehicles with OBD II use a 16-pin connector located in the passenger compartment.

Data stream:

The actual data communications sent from the vehicle's PCM to the data connector.

DEPS:

Digital engine position sensor.

Detonation:

See knock.

DI/DIS:

Direct Ignition/Distributorless Ignition System. A system that produces the ignition spark without the use of a distributor.

DPFE:

Differential pressure feedback-exhaust gas recirculation sensor

DTC:

Diagnostic trouble code. An alphanumeric identifier for a fault condition identified by the on board diagnostic system.

Duty Cycle:

A term applied to signals that switch between on and off. Duty cycle is the percentage of time the signal is on. For example, if the signal is on only one fourth of the time, then the duty cycle is 25%. The PCM uses duty cycle type signals to maintain precise control of an actuator.

EBCM:

Electronic brake control module

EBTCM:

Electronic brake/traction control module

ECM:

Engine control module or electronic control module

ECT:

Engine coolant temperature sensor. See CTS.

EEPROM:

Electrically erasable programmable read only memory

EFE:

Early fuel evaporation

EFI:

Electronic fuel injection. Any system where a computer controls fuel delivery to the engine by using fuel injectors.

EGR:

Exhaust gas recirculation. The PCM uses the EGR system to recirculate exhaust gases back into the intake manifold to reduce emissions. EGR is used only during warm engine cruise conditions.

EOP:

Engine oil pressure (switch)

EOT:

Engine oil temperature (sensor)

EPA:

Environmental protection agency

ESC:

Electronic spark control. An ignition system function that warns the PCM when knock is detected. The PCM then retards spark timing to eliminate the knocking condition.

EST:

Electronic spark timing. An ignition system that allows the PCM to control spark advance timing. The PCM determines optimum spark timing from sensor information – engine speed, throttle position, coolant temperature, engine load, vehicle speed, Park/Neutral switch position, and knock sensor condition.

EVAP:

Evaporative emissions system

FC:

Fan control

Freeze frame:

A block of memory containing DTCs of the vehicle operating conditions for a specific time.

FTP:

Federal test procedure. Strict test of vehicle's emissions.

Ground (GND):

An electrical conductor used as a common return for an electric circuit(s) and with a relative zero potential (voltage).

Hall effect sensor:

Any of a type of sensor utilizing a permanent magnet and a transistorized Hall Effect switch. Hall Effect type sensors may be used to measure speed and position of the crankshaft or camshaft – for spark timing and fuel injector control.

HO2S:

Heated oxygen sensor. See O2S.

HVAC:

Heating, ventilation, & air conditioning (system)

I/M:

Inspection and maintenance. An emission control program.

IAC:

Idle air control. A device mounted on the throttle body which adjusts the amount of air bypassing a closed throttle so that the PCM can control idle speed.

IAT:

Intake air temperature (sensor)

ICM:

Ignition control module.

IMRC:

Intake manifold runner control

IPC:

Instrument panel cluster

ISC:

Idle speed control. A small electric motor mounted on the throttle body and controlled by the PCM. The PCM

can control idle speed by commanding the ISC to adjust its position.

ISO:

International Organization of Standardization also known as International Standards Organization.

KAM:

Keep alive memory

Knock sensor (KS):

Used to detect engine detonation or knock. The sensor contains a piezoelectric element and is threaded into the engine block. Special construction makes the element sensitive only to engine vibrations associated with detonation.

Knock:

Uncontrolled ignition of the air/fuel mixture in the cylinder. Also referred to as detonation or ping. Knock indicates extreme cylinder pressures or “hotspots” that are causing the air/fuel mixture to detonate prematurely.

KOEO:

Key ON engine OFF. Turn the ignition key to on, but don't start the engine.

KOER:

Key ON engine running. Start the vehicle.

LCD:

Liquid crystal display

LTFT:

Long term fuel trim

M/T:

Manual transmission or manual transaxle.

MAF:

Mass air flow (sensor). Measures the amount and density of air entering the engine and sends a frequency or voltage signal to the PCM. The PCM uses this signal in its fuel delivery calculations.

MAP:

Manifold absolute pressure (sensor). Measures intake manifold vacuum or pressure and sends a frequency or voltage signal (depending on sensor type) to the PCM. This gives the PCM information on engine load for control of fuel delivery, spark advance, and EGR flow.

MAT:

Manifold air temperature (sensor). A resistance sensor in the intake manifold that sends a voltage signal to the PCM indicating the temperature of the incoming air. The PCM uses this signal for fuel delivery calculations.

MIL:

Malfunction indicator lamp. The MIL is most commonly known as the check engine or service engine soon light. A required on-board indicator to alert the driver of an emission-related malfunction.

Misfire:

Caused by the air fuel ratio being incorrect.

Monitor:

A test performed by the on-board computer to verify proper operation of emission-related systems or components.

MPFI or MFI:

Multi-port fuel injection. MPFI is a fuel injection system using one (or more) injector(s) for each cylinder. The injectors are mounted in the intake manifold, and fired in groups rather than individually.

NOx:

Oxides of nitrogen. The system EGR and Camshafts injects exhaust gases into the intake manifold to reduce these gases at the tailpipe.

O2S:

Oxygen sensor. Generates a voltage of 0.6 to 1.1 volts when the exhaust gas is rich (low oxygen content). The voltage changes to 0.4 volts or less when the exhaust gas is lean (high oxygen content). This sensor only operates after it reaches a temperature of approximately 349°C (660°F). O2 sensors are usually found both upstream and downstream of the catalytic converter. The PCM uses these sensors to fine tune the air-fuel ratio and to monitor the efficiency of the catalytic converter. See Bank 1, Bank 2, Sensor 1, Sensor 2.

OBD II:

On-board diagnostics, second generation. OBD II is a U.S. Government-mandated standard requiring all cars and light trucks to have a common data connector, connector location, communication protocol, DTCs and code definitions. OBD II first appeared on vehicles in late 1994, and is required to be present on all cars sold in the US after January 1, 1996.

ODM:

Output device monitor

Open loop (OL):

A control system mode that does not monitor the output to verify if the desired results were achieved. A fuel delivery system usually operates in open loop mode during cold engine warm-up because the oxygen sensors are not yet ready to send a signal. Without the oxygen sensor signal, the computer cannot check the actual results of combustion.

PCM:

Powertrain control module. The brains of the engine and transmission control systems housed in a metal box with a number of sensors and actuators connected via a wiring harness. Its job is to control fuel delivery, idle speed, spark advance timing, and emission systems. The PCM receives information from sensors, then energizes various actuators to control the engine. The PCM is also known as the ECM (engine control module).

Pending codes:

Also referred to as continuous memory codes and maturing diagnostic trouble codes. Pending codes may be set by emission related powertrain components and systems. If the fault does not occur after a certain number of drive cycles, the code is erased from memory.

PID:

Parameter identification. Identifies an address in memory which contains vehicle operating information.

PNP:

Park/neutral position. A switch that tells the PCM when the gear shift lever is in the park or neutral position. When in park or neutral, the PCM operates the engine in an idle mode.

PROM:

Programmable read-only memory. The PROM contains programming information the PCM needs to operate a specific vehicle model/engine combination.

PSPS:

Power steering pressure switch

Purge solenoid:

Controls the flow of fuel vapors from the carbon canister to the intake manifold. The canister collects vapors evaporating from the fuel tank, preventing them from escaping to the atmosphere and causing pollution. During warm engine cruise conditions, the PCM energizes the Purge Solenoid so the trapped vapors are drawn into the engine and burned.

PWM:

Pulse width modulated

PZM:

Platform zone module

QDM:

Quad driver module

RAM:

Random access memory

Relay:

An electromechanical device in which connections in one circuit are switched.

Reluctance sensor:

A type of sensor typically used to measure crankshaft or camshaft speed and/or position, driveshaft speed, and wheel speed.

ROM:

Read-only memory. Permanent programming information stored inside the PCM, containing the information the PCM needs to operate a specific vehicle model/engine combination.

RPM:

Revolutions per minute

SAE:

Society of Automotive Engineers

Scan tool:

A device that interfaces with and communicates information on a data link.

SDM:

Sensing and diagnostic module

Sensor x:

A standard term used to identify the location of oxygen sensors. Sensor 1 is located upstream of the catalytic converter. See O2S, Bank 1, Bank 2.

Sensor:

Any device that reports information to the PCM. The job of the sensor is to convert a parameter such as engine temperature into an electrical signal that the PCM can understand.

SFI or SEFI:

Sequential fuel injection or sequential electronic fuel injection. A fuel injection system that uses one or more injectors for each cylinder. The injectors are mounted in the intake manifold and are fired individually.

Solenoid:

A device consisting of an electrical coil which when energized, produces a magnetic field in a plunger, which is pulled to a central position. A solenoid may be used as an actuator in a valve or switch.

STFT:

Short term fuel trim

STS:

Service throttle soon

TAC:

Throttle actuator control

TBI:

Throttle body injection. A fuel injection system having one or more injectors mounted in a centrally located throttle body, as opposed to positioning the injectors close to an intake valve port. TBI is also called Central Fuel Injection (CFI) in some vehicles.

TCC:

Torque converter clutch

TCM:

Transmission control module

TCS:

Traction control system for PCM and brakes

TDC:

Top dead center. When a piston is at its uppermost position in the cylinder.

TFP:

Transmission fluid pressure

TFT:

Transmission fluid temperature (sensor)

Throttle body:

A device which performs the same function as a carburetor in a fuel injection system. On a throttle body injection (TBI) system, the throttle body is both the air door and the location of the fuel injectors. On port fuel injection systems (PFI, MPFI, SFI, etc.), the throttle body is simply an air door. Fuel is not added until the injectors at each intake port are activated. In each case, the throttle body is attached to the accelerator pedal.

TPS:

Throttle position sensor. Potentiometer-type sensor connected to the throttle shaft. Its voltage signal output increases as the throttle is opened. The PCM uses this

signal to control many systems such as idle speed, spark advance, fuel delivery, etc.

Traction assist:

Assist in traction with brakes only.

Trip:

Vehicle operation for a period of time so the systems can be monitored.

TTS:

Transmission temperature sensor. A resistance sensor mounted in the transmission housing in contact with the transmission fluid. It sends a voltage signal to the PCM indicating the temperature of the transmission.

VECI:

Vehicle emission control information. A decal located in the engine compartment containing information about the emission control systems found on the vehicle. The VECI is the authoritative source for determining whether a vehicle is OBD II compliant.

VIN:

Vehicle identification number. This is the factory-assigned vehicle serial number. This number is stamped on a number of locations throughout the vehicle, but the most prominent location is on top of the dashboard on the driver's side, visible from outside the car. The VIN includes information about the car, including where it was built, body and engine codes, options, and a sequential build number.

VSS:

Vehicle speed sensor. Sends a frequency signal to the PCM. The frequency increases as the vehicle moves faster to give the PCM vehicle speed information used to determine shift points, engine load, and cruise control functions.

VTD:

Vehicle theft deterrent

Warm-up cycle:

Warm-up cycle is when the engine coolant temperature rises at least 40 degrees above that at engine start up.

WOT:

Wide-open throttle. The vehicle operating condition brought about when the throttle is completely (or nearly) open. The PCM typically delivers extra fuel to the engine and de-energizes the A/C compressor at this time for acceleration purposes. The PCM uses a switch or the TPS to identify the WOT condition.

13 Appendix C—OBD I Data Link Connectors

94-95 GM Cars, Light Trucks & Vans

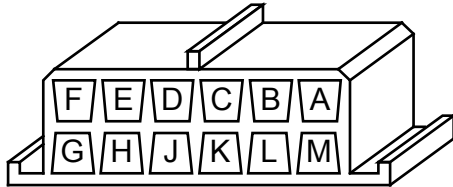

ALDL DLC

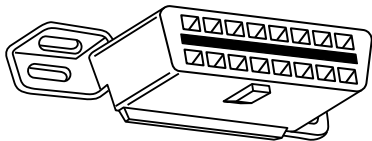

OBD II (J1962) DLC

Model	Engine	VIN	Year	DLC Adapter
Achieva	2.3L DOHC PFI	A, D	94	ALDL
		D	95	ODB II
	2.3L SOHC PFI	3	94	ALDL
		M	94-95	ALDL
Aurora	4.0L SFI	C	95	ODB II
Beretta/ Corsica	2.2L TBI	4	9-95	ALDL
		A	94	ALDL
		M	94-95	ALDL
Camaro, Firebird, Trans Am	3.4L PFI OHV	S	94-95	ALDL
		K	95	ODB II
	3.8L SFI	P	94 95	ALDL ALDL/ODB II
		W	94, 95	ALDL, OBD II
Caprice/ Impala	4.3L V-8 MFI	P	94, 95	ALDL, OBD II
		W	94-95	ALDL
		W	94-95	ALDL
Cavalier	2.2L TBI, SFI	4	94, 95	ALDL, OBD II
		D	95	ODB II
		T	95	ALDL
Century	2.2L	4	95	ALDL
		M	94-95	ALDL
Concours	4.6L OHC	Y, 9	94-95	ALDL
		B	94	ALDL
Corvette	5.7L OHC (ZR-1)	J	94-95	ODB II
		P	94-95	ODB II
Cutlass Ceira	2.2L PFI	4	94-95	ALDL
		M	94-95	ALDL
Cutlass Supreme	3.1L MFI, SFI	M	94-95	ALDL
		X	94-95	ALDL
DeVille	4.6L OHC	Y, 9	94-95	ALDL
		B	94-95	ALDL
Eighty-Eight, Ninety-Eight, Park Avenue, Bonnville	3.8L SFI	L, K	94-95	ODB II
		1	95	ODB II

Eldorado, Seville	4.6L OHC	Y, 9	94-95	ALDL
	5.7L TBI, SFI	P	94-95	ALDL
Grand Am	2.3L PFI DOHC	A, D	94-95	ALDL
	2.3L PFI SOHC	3	94	ALDL
	3.1L SFI	M	94-95	ALDL
Gran Prix	2.3L DOHC	D	94-95	ODB II
	3.1L MFI	M	94-95	ALDL
	3.4L PFI OHC	X	94-95	ALDL
LeSabre	3.8L MFI	L	94-95	ODB II
Lumina, Monte Carlo	3.1L PFI, SFI	M, T	94-95	ALDL
	3.4L MFI OHC	X	94-95	ALDL
Regal	3.1L MFI	M	94-95	ALDL
	3.8L SFI MFI	L	94-95	ALDL
Riviera	3.8L MFI	K	95	ODB II
	3.8L SFI SC	1	95	ODB II
Roadmaster	5.7L	P	94-95	ALDL
Satrum SC1, SL, SL1, SW1	1.9L SOHC	8	94-95	ALDL
Satrum SC2, SL, SL2, SW2	1.9L DOHC	7	94-95	ALDL
Skylark	2.3L DOHC	D	95	ALDL
		3	94	ALDL
	3.1L	M, T	94-95	ALDL
		K	95	ODB II
Sunbird	3.1L PFI	T	94	ALDL
Sunfire	2.0L TBI OHV	H	94	ALDL
		4	95	ODB II
		D	95	ODB II
C Series 4x2 & K Series 4x4 Conventional Cab Pickup, Sierra, Blazer, Suburban, Yukon & Tahoe	5.0L TBI	H	94-95	ALDL
		K	94-95	ALDL
		P	94-95	ALDL
		F	94-95	ALDL
G Series 4x2 Van (full size) Chevy van, Sport van, GMC Vandura and Rally	5.0L TBI	H	94-95	ALDL
		K	94-95	ALDL
		P, Y	94-95	ALDL
M Series 4x2 & L Series 4x4 Small Van Astro, Safari	4.3L CPI	W	94-95	ALDL
		Z	94	ALDL
P Series 4x2 Forward Control Parcel/Delivery commercial vans, Motorhomes	4.3L TBI	Z	94-95	ALDL
		K	94-95	ALDL
		Y	94	ALDL
		F	94-95	ALDL
		N	94-95	ALDL
		N	94-95	ALDL

S Series 4x2 & T Series 4x4	2.2L MFI	4	94-95	OBD II
	4.3L CPI	W	94-95	ALDL OBD II
Small Conventional Cab, Blazer, Bravada, Jimmy, Pickup & Sonoma	4.3L TBI	Z	94-95	ALDL OBD II
	3.1L TBI	D	94-95	ALDL
U & X Series 4x2	3.1L TBI	D	94-95	ALDL
	3.8L PFI	L	94-95	ALDL
All Purpose Vehicle, Lumina APV, Silhouette, Trans Sport				

Note: Data link connectors (DLC) are located under the dash, near the steering wheel.



EEC-IV DLC



MECS 6-Pin DLC

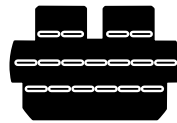

MECS 17-Pin DLC



MCU DLC

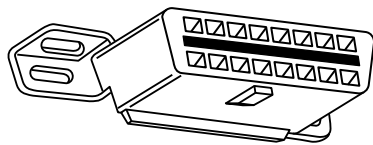

OBD II (J1962) DLC

Ford, Lincoln & Mercury Cars, Light Trucks & Vans

Model	Engine	Year	DLC	DLC Location
Aspire	3.1L	94-95	MECS 17	Engine compartment, left rear corner
Capri	1.6L, 1.6L T	91-94	MECS 6	Engine compartment, right rear corner
	2.3L, 2.3L T, 3.8L, 5.0L, 5.0LHO	84-86	EEC-IV	Engine compartment, left rear corner

Continental	3.8L, 4.6L, 5.0L	88	EEC-IV	Engine compartment, right corner near firewall
		89-94		Right rear of engine compartment
	4.6L	95	OBD II	Below instrument panel right of steering wheel
Contour	2.0L, 2.5L	95	EEC-IV	Engine compartment, left side by shock tower
Cougar	2.3L, 2.3L T, 3.8L, 5.0L, 5.0LHO	84-85	EEC-IV	Right inner fender of engine compartment
		86-90		Engine compartment, in front of left shock tower
		91-95		Engine compartment, in front of right shock tower
	4.6L	94-95	OBD II	Below instrument panel to right of steering wheel
Escort/Lynx/EXP	1.6L, 1.6L Turbo, 1.9L	84-90	EEC-IV*	Right fender apron near firewall and shock tower
		91-95	EEC-IV	Engine compartment, left rear corner
Escort	1.8L	91-95	MECS 17	Engine compartment, left rear corner near firewall
Festiva	1.3L	90-93	MECS 6	Engine compartment, left rear corner
Grand Marquis, Crown Victoria, Colony Park, Contry Squire	4.6L, 5.0L	84	EEC-IV*	Above right wheel well
		85-94		Front left fender apron above wheel well
	4.6L	95	OBD II	Below instrument panel to right of steering wheel
Grand Marquis/Crown Victoria (Police)	5.8L	84	MCU	Above right wheel well
		85-91		Front of left fender apron above wheel well
Marquis/LTD	2.3L, 3.8L	84-86	EEC-IV	Engine compartment, left rear corner
Mark VII	5.0L, 5.0L HO	84-89	EEC-IV*	Engine compartment, right corner near firewall
		90-92		Front of right fender apron
Mark VIII	4.6L	93-95	EEC-IV	Engine compartment on top of left wheel well

Mustang	2.3L, 2.3L Turbo, 5.0L, 5.0L HO, 5.0L SHP	84-85	EEC-IV	Center of left fender apron
		86-93		Left rear corner of engine compartment on shock tower
		94-95		Rear of right shock tower
	3.8L	84-85	EEC-IV	Center of left fender apron
	86-93	Left rear corner of engine compartment on shock tower		
	3.8L	94-95	OBD II	Below left side of glove compartment
Mystique	2.0L, 2.5L	95	EEC-IV	Left side of engine compartment near shock tower
Probe	2.0L (A/T only in 93)	93	MECS 17	Left rear of engine compartment near strut tower
		93-95	EEC-IV	Left rear of engine compartment near strut tower
	2.2L, 2.2L Turbo	89-92	MECS 6	Left rear of engine compartment near strut tower
	2.5L	93-95	MECS 17	Left front of engine compartment near battery.
	3.0L	91-92	EEC-IV	Left rear of engine compartment near strut tower
Sable	3.0L, 3.8L	86-87	EEC-IV	Engine compartment near alternator
		88-95		Right rear corner of engine compartment
Scorpio	2.9L	87-89	EEC-IV	Engine compartment, right rear corner
Taurus	2.5L, 3.0L FF, 3.0L, 3.0L SHO, 3.2L, 3.8L	86-87	EEC-IV	Engine compartment near alternator
		88-95		Right rear corner of engine compartment
Tempo /Topaz	2.3L HSC, 2.3L HSO, 3.0L	84-92	EEC-IV	Right rear corner of engine compartment
		93-94		Left strut tower
Thunderbird	2.3L, 2.3L T, 3.8L, 3.8L SC, 5.0L, 5.0L HO	84-85	EEC-IV	Right inner fender of engine compartment
		86-90		Engine compartment, in front of left shock tower
		91-95		Engine compartment, in front of right shock tower
	4.6L	94-95	OBD II	Below instrument panel to right of steering wheel

Town Car	4.6L	95	OBD II	Below instrument panel right of steering wheel
		84		EEC-IV*
	4.6L, 5.0L	85-90		Left fender apron, near or above wheel well
		91-94		Above left wheel well
Tracer	1.8L	88-89	MECS 6	Engine compartment, left rear corner near firewall
		91-95	MECS 17	Engine compartment, left rear corner near firewall
	1.9L	91-95	EEC-IV	Engine compartment, left rear corner
XR4Ti	2.3L Turbo	85-88	EEC-IV	Engine compartment, right fender apron above wheel well
Aerostar	2.3L, 2.8L, 3.0L, 4.0L	86-92	EEC-IV	Left front fender below starter relay
		93-95		Left rear engine compartment on firewall
Bronco	4.9L*, 5.0L*, 5.8L* *84-85 A/T Only	84-87	EEC-IV	Right inner fender near starter relay
		88-95		Left front corner of engine compartment
Bronco II	2.8L, 2.9L	84-88	EEC-IV	Right inner fender near starter relay
		89-90		Right fender panel below engine compartment fuse block
E-Series, Econoline Van	4.9L, 5.0L, 5.8L, 7.3L D, 7.3L TD	84-91	EEC-IV	Right front fender near starter relay
		92-95		Left front corner of engine compartment
	5.8L > 8,500 GVW	96	EEC-IV	Left rear of engine compartment
	5.8L > 8,500 GVW in 49 States, ex CA	97	EEC-IV	Left rear of engine compartment
	7.5L W/Fed Emiss	96	EEC-IV	Left rear of engine compartment
	7.5L > 14,000 GVW	97-98	EEC-IV	Left front corner of engine compartment
	7.5L > 8,500 GVW in 49 States ex CA	97-98	EEC-IV	Left front corner of engine compartment
Explore	4.0L	91-95	EEC-IV	Right rear of engine compartment

F-Series Pickup	4.9L, 5.0L, 5.8L, 7.3L D, 7.3L TD, 7.5L	84-87 88-95	EEC-IV	Right inner fender near starter relay Left front fender apron in rear of engine compartment
	5.8L > 8,500 GVW	96-98	EEC-IV	Left rear of engine compartment
	5.8L > 8,500 GVW in 49 States, ex CA	97	EEC-IV	Left rear of engine compartment
	7.0L	91-96	EEC-IV	Left rear of engine compartment
	7.0L > 14,000 GVW	97-98	EEC-IV	Left rear of engine compartment
	7.5L W/Fed Emiss	96	EEC-IV	Left rear of engine compartment
	7.5L > 8,500 GVW in 49 States ex CA	97-98	EEC-IV	Left rear of engine compartment
Ranger	2.3L	84	MCU	Right front inner fender panel
	2.3L, 2.8L, 2.9L, 3.0L, 4.0L	84-85	EEC-IV	Right front inner fender panel
		86-92		Right rear fender apron near fuel pump relay
		92-94		Left front inner fender by fuse/relay block
2.3L, 3.0L, 4.0L	95	OBD II	Below instrument panel, right of steering wheel	
windstar	3.0L, 3.8L	95	OBD II	Below instrument panel, right of steering wheel

*Early models are equipped with the EEC III diagnostic system which is not supported by this tool.

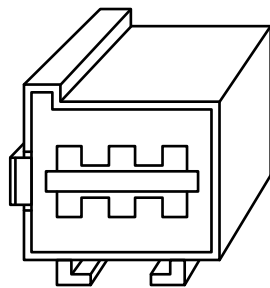

LH DLC

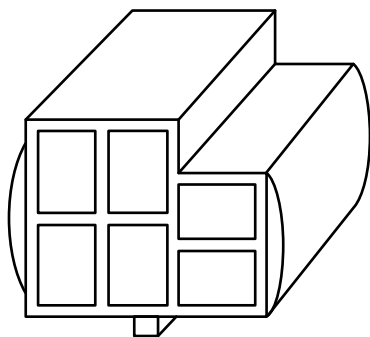

SCI DLC

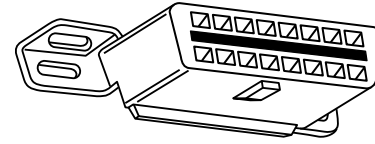

OBD II (J1962) DLC

Chrysler Cars, Light Trucks & Vans

Model	Engine	Year	DLC	DLC Location
Acclaim	ALL	89-95	SCI	Front of left shock/strut tower, near the SBEC/SMEC module
Aries K, Reliant	ALL	89	SCI	At front of left shock/strut tower
Caravan, Grand Caravan	ALL	89-91	SCI	In front of left fender panel below relays
		92-93		In engine compartment near PC module
		94-95		In engine compartment on left side of firewall
Cherokee	ALL	91-95	SCI	In front of left fender apron behind air cleaner
Cirrus	ALL	95	OBD II	Left of steering column under dash on body control module
Comanche	ALL	91-92	SCI	In front of left fender apron behind air cleaner
Concorde, Intrepid, Vision	ALL	93-95	LH	Right of steering column under dash
Dakota	ALL	91	SCI	Engine compartment, right corner of firewall
Daytona	ALL	89-93	SCI	At front of left shock/strut tower
Dynasty	ALL	89-93	SCI	Front of left shock/strut tower near SBEC/PCM
Fifth Avenue, Imperial	ALL	90	SCI	In engine compartment near air filter housing
		91-93		On front of left fender panel by SMEC/SBAC
Grand Cherokee, Grand Wagoneer	ALL	93-	SCI	Right rear of engine compartment
Horizon, Omni	ALL	89-90	SCI	Front of left side shock tower by relays & SMEC
Lancer	ALL	89	SCI	At front of left shock/strut tower
LeBaron Coupe, Convertible	ALL	89-95	SCI	At front of left shock/strut tower
LeBaron Sedan, GTS	ALL	89-95	SCI	Front of left shock/strut tower near SBEC/PCM
LHS	ALL	94-95	LH	Right of steering column under dash

Neon	ALL	95	OBD II	Under left side of dash.
New Yorker	ALL	89-93	SCI	Front of left shock tower near the SBEC/SMEC module
		94-95	LH	Right of steering column under dash
Pickup D/W, RAM Series	5.2L, 5.9L	89-95	SCI	On left side of firewall near master cylinder
	3.9L, 5.9L	89-95		In engine compartment on right side of firewall
	8.0L	94-95		In engine compartment on right side of firewall
Ram Wagon/Van, B-Van	5.2L, 5.9L	89-90	SCI	On left side of firewall below cowl
	5.2L, 5.9L	91-95		On center of firewall next to SBEC/PCM
	5.2L CNG 3.9L	92-95 89-95		Under center of dash panel In engine compartment on right side of firewall
Ramcharger	ALL	89-90 91-93	SCI	On left side corner of firewall below cowl In engine compartment, near master cylinder
Sebring Conv/Avenger	ALL	95		OBD II

Shadow, Sundance	ALL	89-95	SCI	Front of left shock/strut tower near SBEC/PCM
Spirit	ALL	89-95	SCI	Front of left shock/strut tower near SBEC/PCM
Stratus	ALL	95	OBD II	Left of steering column under dash on body control module
Town & County	ALL	90-91	SCI	On front of left fender panel below relays
		92-93		In engine compartment near PCM module
		94-95		In engine compartment on left side of firewall
Voyager, Grand Voyager	ALL	89-91	SCI	In front of left fender panel below relays
		92-93		In engine compartment near PCM module
		94-95		In engine compartment near PCM module on left side of firewall
Wrangler	ALL	91-95	SCI	In front of left fender apron behind air cleaner near SBEC

14 Limited Warranty

THIS WARRANTY IS EXPRESSLY LIMITED TO ORIGINAL RETAIL BUYERS OF BOSCH ELECTRONIC DIAGNOSTIC TOOLS (“UNITS”).

BOSCH Automotive Service Solutions LLC Units are warranted against defects in materials and workmanship for one year (12 months) from date of delivery. This warranty does not cover any Unit that has been abused, altered, used for a purpose other than that for which it was intended, or used in a manner inconsistent with instructions regarding use. The sole and exclusive remedy for any Unit found to be defective is repair or replacement, the option of BOSCH. In no event shall BOSCH be liable for any direct, indirect, special, incidental or consequential damages (including lost profit) whether based on warranty, contract, tort or any other legal theory. The existence of a defect shall be determined by BOSCH in accordance with procedures established by BOSCH. No one is authorized to make any statement or representation altering the terms of this warranty.

DISCLAIMER

THE ABOVE WARRANTY IS IN LIEU OF ANY OTHER WARRANTY, EXPRESS OR IMPLIED, INCLUDING ANY WARRANTY OF MERCHANTABILITY OR FITNESS FOR A PARTICULAR PURPOSE.

SOFTWARE

Unit software is proprietary, confidential information protected under copyright law. Users have no right in or title to Unit software other than a limited right of use revocable by BOSCH. Unit software may not be transferred or disclosed without written consent of BOSCH. Unit software may not be copied except in ordinary backup procedures.

TECHNICAL SUPPORT

If you have any questions on the operation of the product, please call 1-800-228-7667 or email tech@actron.com.

REPAIR SERVICE

- Please contact Technical Support for troubleshooting and service options prior to sending any unit in for repair.
- To send a unit in for repair, go to repairtrack.bosch-automotive.com and follow the online instructions. This web site will also have the latest Service policies and service center locations. If you do not have internet access, please call 1-800-344-4013.

Bosch Automotive Service Solutions Inc.

3000 Apollo Drive
Brook Park, OH 44142
USA
Telephone 1-800-228-7667
www.actron.com